

INSTALLATION INSTRUCTIONS

-CG2541

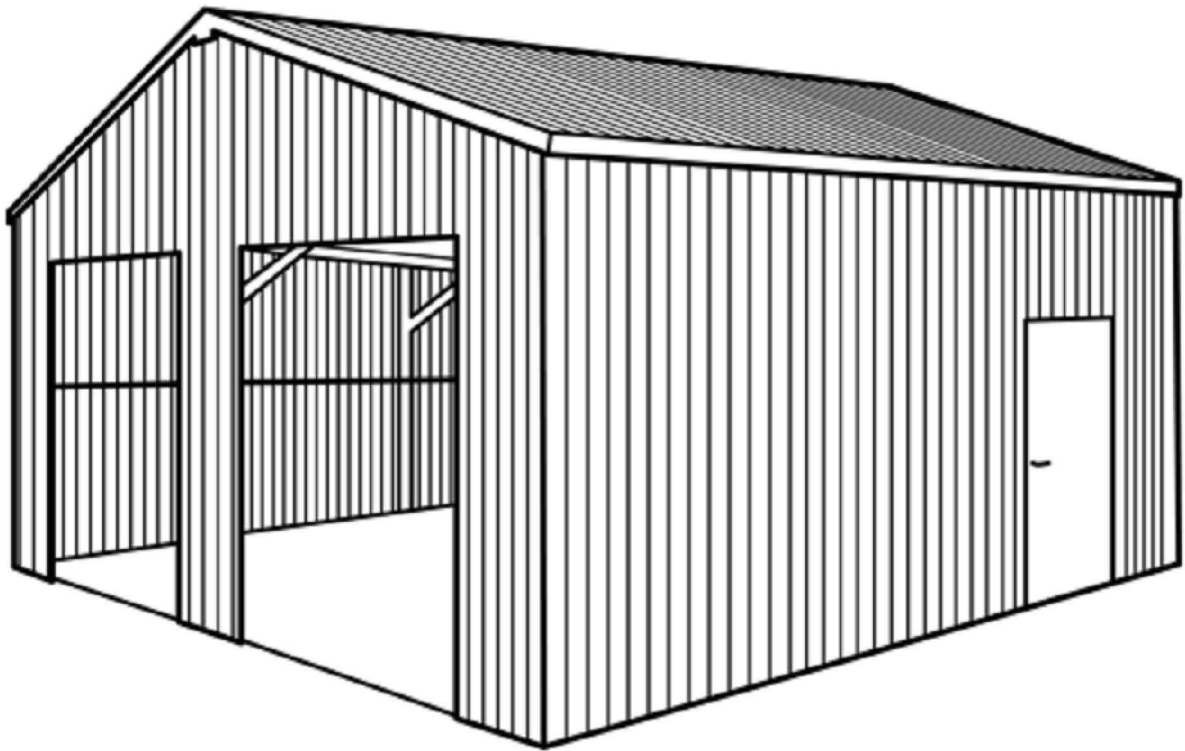

- Please read and understand the product manual completely before assembly.
- Check against the parts list to make sure all parts are received.
- Wear proper safety goggles or other protective gears while in assembly.
- Do not return the product to dealer. They are not equipped to handle your requests.



Important tips

Dear user:

Hello!

In order to offer you a better use experience, we recommend that after the installation of the product, you shall carry out anti-rust protection treatment for the cutting end directly exposed to the air, the paint scratch and the surface zinc layer damage caused during the installation process. Due to the limitation of shipping conditions, we cannot provide you with flammable and explosive products such as antirust paint or antirust oil. Please purchase them locally or contact the dealer. After antirust treatment, the service life of the product can be effectively extended.







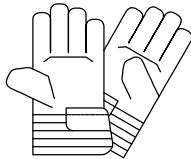

Manufacturer
January 2023

CONTENTS

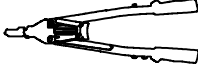
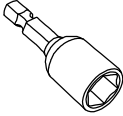
1. Before You Start	4
2. Option 1 Concrete Pad Layout	5
3. Option 2 Concrete Footing Layout CG2541	6
4. Part List.....	7-12
5. Analysis Diagram.....	13-14
6. Installation Of Framework.....	15-31
7. Installation Of Wall Tile.....	32-41
8. Installation Of Side Door	42
9. Installation Of Roller Door (Needs to be purchased separately).....	45
10. Installation Of Framework.....	50
11. Installation Of Transparent Panel.....	52

BEFORE YOU START

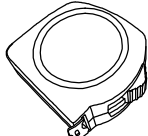
Items Required:

Tools					
	gloves	Safety Glasses	Shoes	Riveting Gun	Sleeve
Tools					
	Power drill	Screw driver	Pencil	Tape Measure	Ladder

- Clear a working area to allow access on 4 sides. A raised work surface will make assembly easier.
- Please choose a dry and calm day to start assembly. Do not attempt installation in rainy or windy day.
- Keep roof clear of leaves and snow with long handled, soft-bristled broom. Heavy amounts to snow on roof can damage building, making it unsafe to enter.
- All parts are identified so when working through the instructions page by page the diagrams show where each part is positioned.
- Before starting, to avoid any accidental injury, we recommend the use of gloves to protect your hands, safety glasses to protect your eyes and shoes or boots to protect your feet.
- Please keep children away from your construction site.
- Most assembly can be completed by one person, assistance may be needed when you reach the erection stage.
- Cleaning should be performed as often as is required to remove any dirt, salt, and pollutants.
- Please note: Some local government authorities have rules & regulations on shed installation and you may need approval to erect this shed.

STEPS:

1. When completed place shed in position and anchor securely to the ground.
2. Clean up all metal pieces, rivets and screws.

OPTION 1 - CONCRETE PAD LAYOUT

Unit:mm

Depth of cement

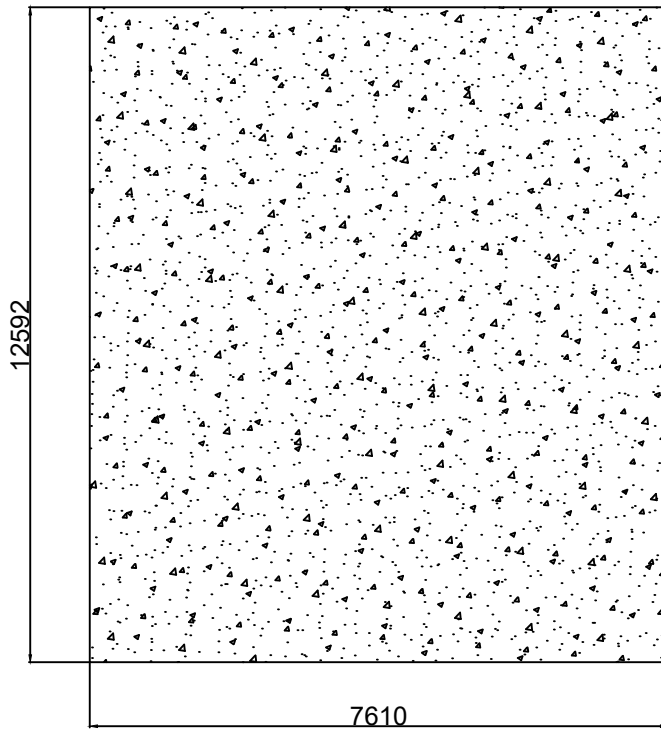
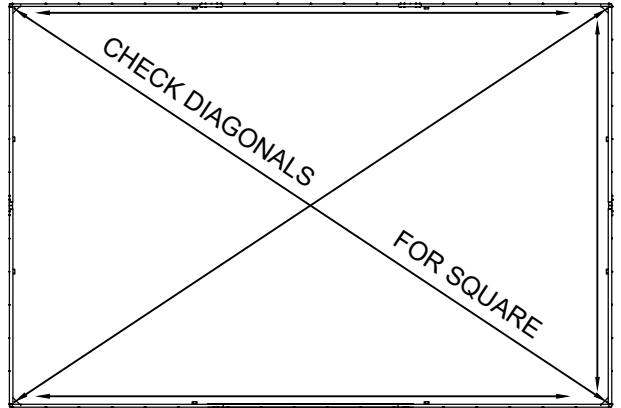
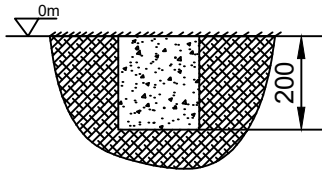

Depth of cement

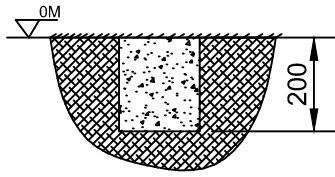

Note: the ground anchor is installed on the cement block.



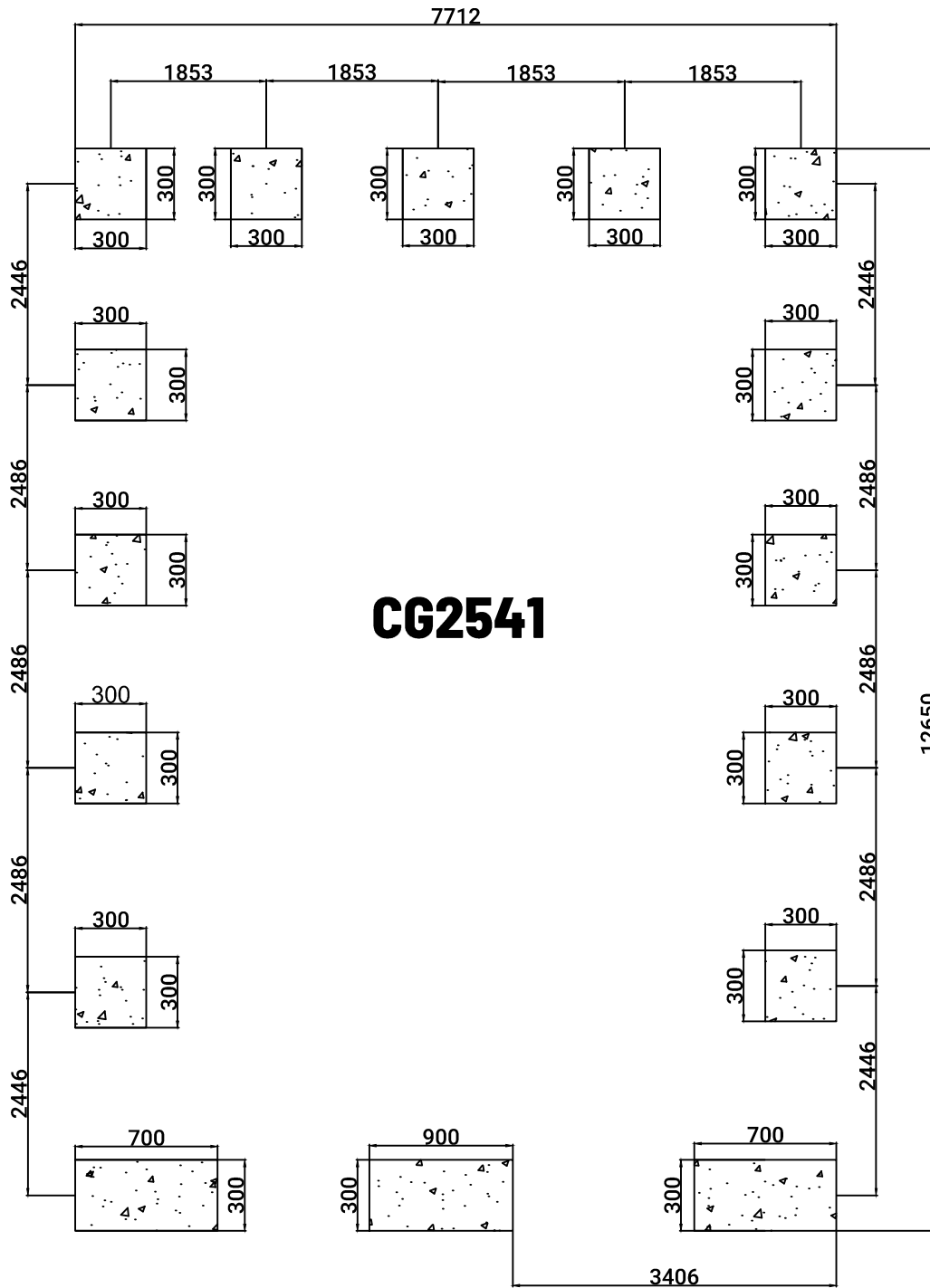













Back

















CG2541

Front

PART LIST

Part No.	Picture	Specification	Qty
1		1550*880mm	62
2		1550*880mm	1
3		1550*880mm	4
4		1550*880mm	1
5		1390*880mm	9
6		1390*880mm	1
7		1050*880mm	1
8		1050*300mm	1
9		1830*880mm	30
10		2180*880mm	30
11		1972*880mm	1
12		1550*710mm	2
13		1390*710mm	2
14		432*880mm	1
15		656*880mm	1
16		880*880mm	1



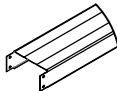

PART LIST

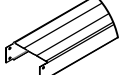
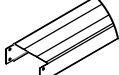
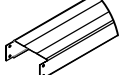
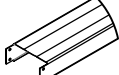
Part No.	Picture	Specification	Qty
17		1104*880mm	1
18		1210*880mm	1
19		1104*880mm	1
20		880*880mm	1
21		656*880mm	1
22		432*880mm	1
23		692*880mm	1
24		916*880mm	1
25		1140*880mm	1
26		1364*880mm	1
27		1470*880mm	1
28		1364*880mm	1
29		1140*880mm	1
30		916*880mm	1
31		692*880mm	1
32		2968mm	4





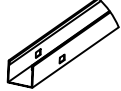





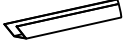
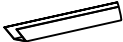
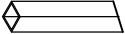

PART LIST

Part No.	Picture	Specification	Qty
33		2900mm	24
34		2090mm	4
35		1370mm	2
36		1890mm	2
37		2862mm	2
38		1851mm	14
39		2420mm	11
40		2484mm	18
41		773mm	1
42		719mm	1
43		924mm	1
44		502mm	4
45		369mm	4
46		1852mm	4
47		1900mm	24
48		1751mm	20



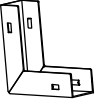



PART LIST

Part No.	Picture	Specification	Qty
49		876mm	8
50		1000mm	8
51		1000mm	8
52		1924mm	8
53		1918mm	32
54		1500mm	16
55		600mm	32
56		2484mm	50
57		200mm	66
58		800mm	10
59		877mm	15
60		2010mm	22
61		828mm	2
62		1920mm	1
63		1920mm	1
64		876mm	1

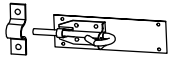
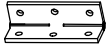
PART LIST

Part No.	Picture	Specification	Qty
65		1196mm	2
66		2619mm	4
67		2780mm	2
68		2025mm	2
69		932mm	1
70		1996mm	2
C72		50*40*39	25
S12		M5*20	4490
S13		M5*50	15
C20		155*18*24	8
M35		35*0.5	4
C12		75*75*25	4
L3		Ø15*9.2	20
L1A		28*24*16.5	6
S5		Ø11*1.5	20
S3		M5*12	28



PART LIST

Part No.	Picture	Specification	Qty
H13		172*57	1
SH1		63*43	2
S7		Ø3.2*11	24
S11		M8*80	25
C14		40*40*40	100
C73		140*150	26
LOGO		295*190	2
UV3		50	3

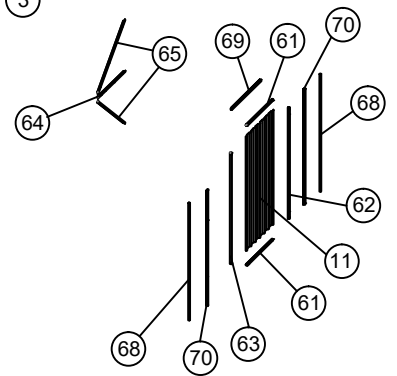
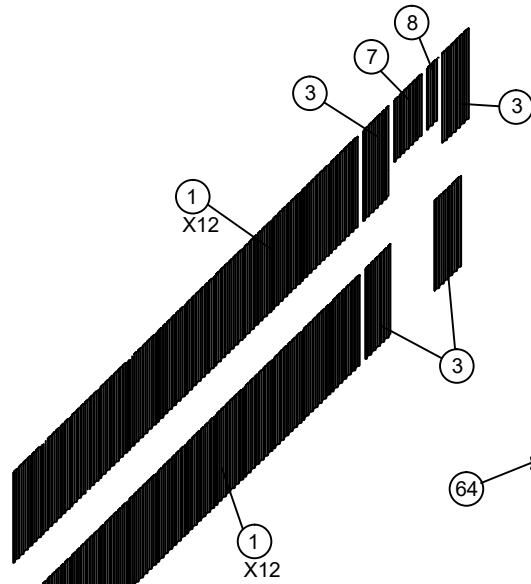
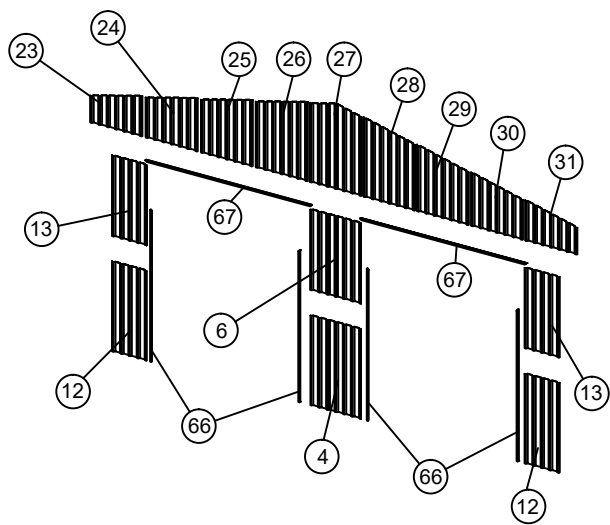
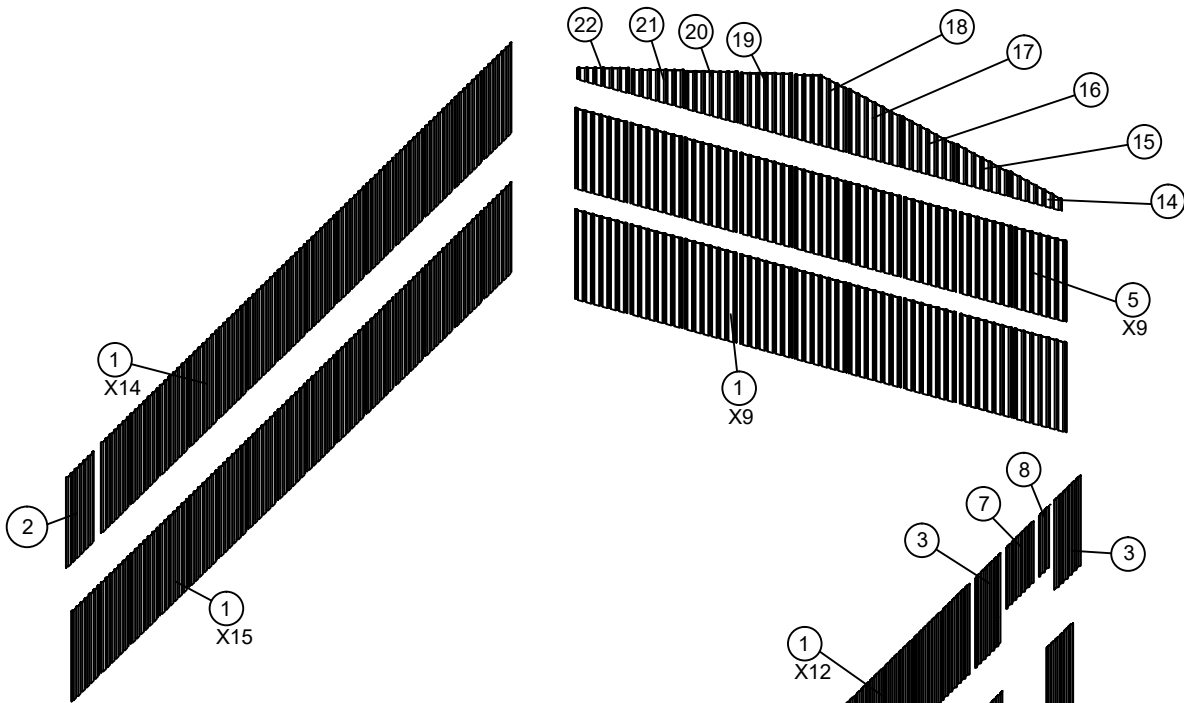
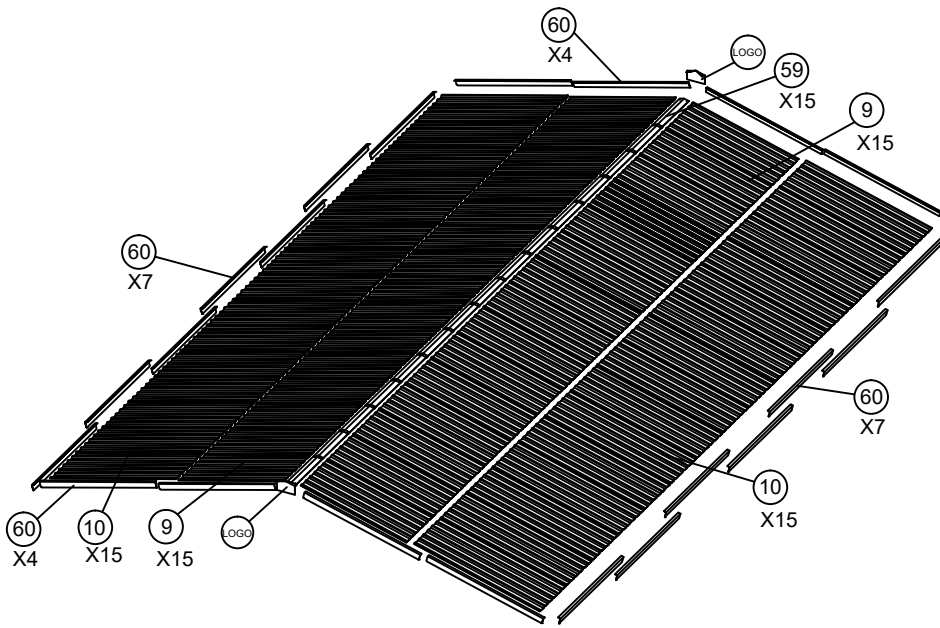
ANALYSIS DIAGRAM





INSTALLATION OF FRAMEWORK

PART	NO.	Qty	PART	NO.	Qty
	33	2		S12	16

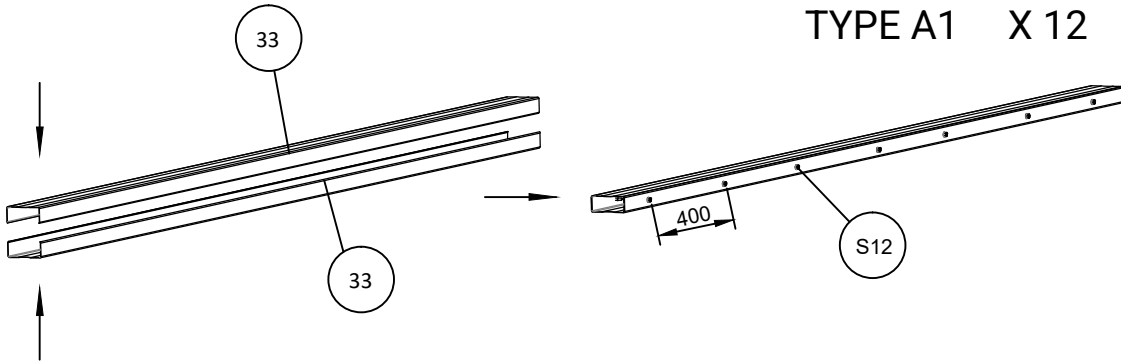
X 12



TIPS: Use labels to mark installed components for easy access.



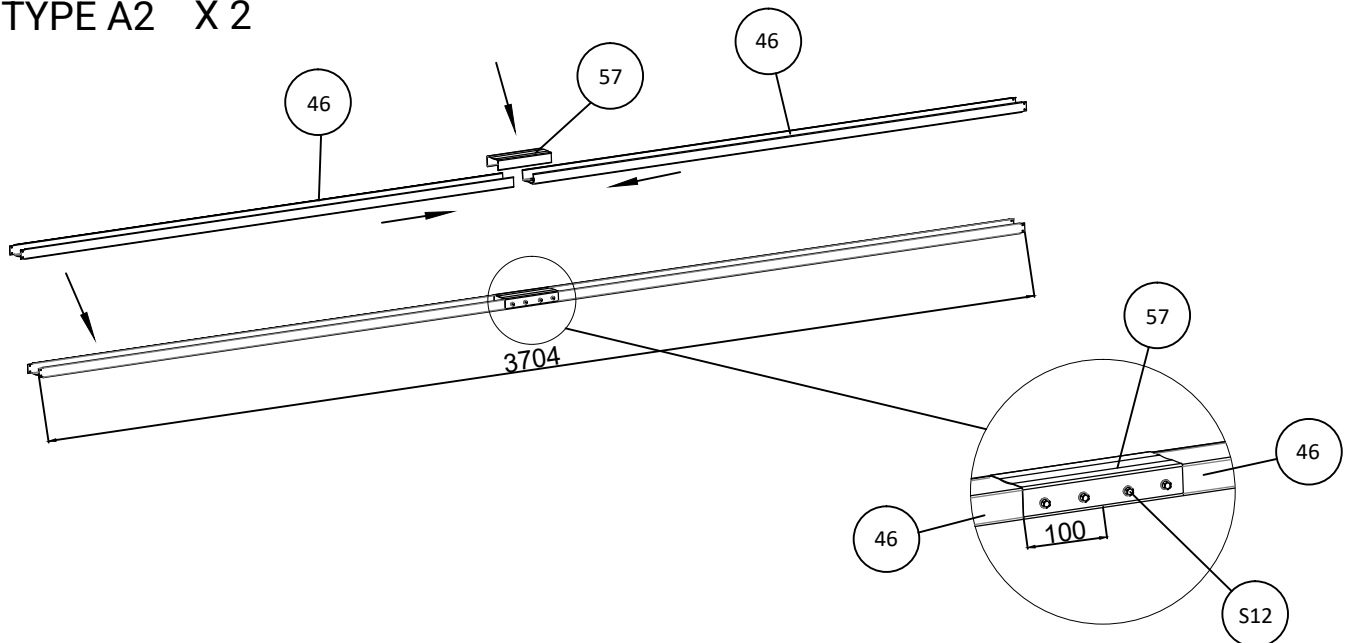

PART	NO.	Qty	PART	NO.	Qty	PART	NO.	Qty
	46	2		57	1		S12	8

X 2

TYPE A2 X 2





INSTALLATION OF FRAMEWORK

PART	NO.	Qty	PART	NO.	Qty	PART	NO.	Qty	PART	NO.	Qty
	47	6		48	1		49	2		S12	38

X 4

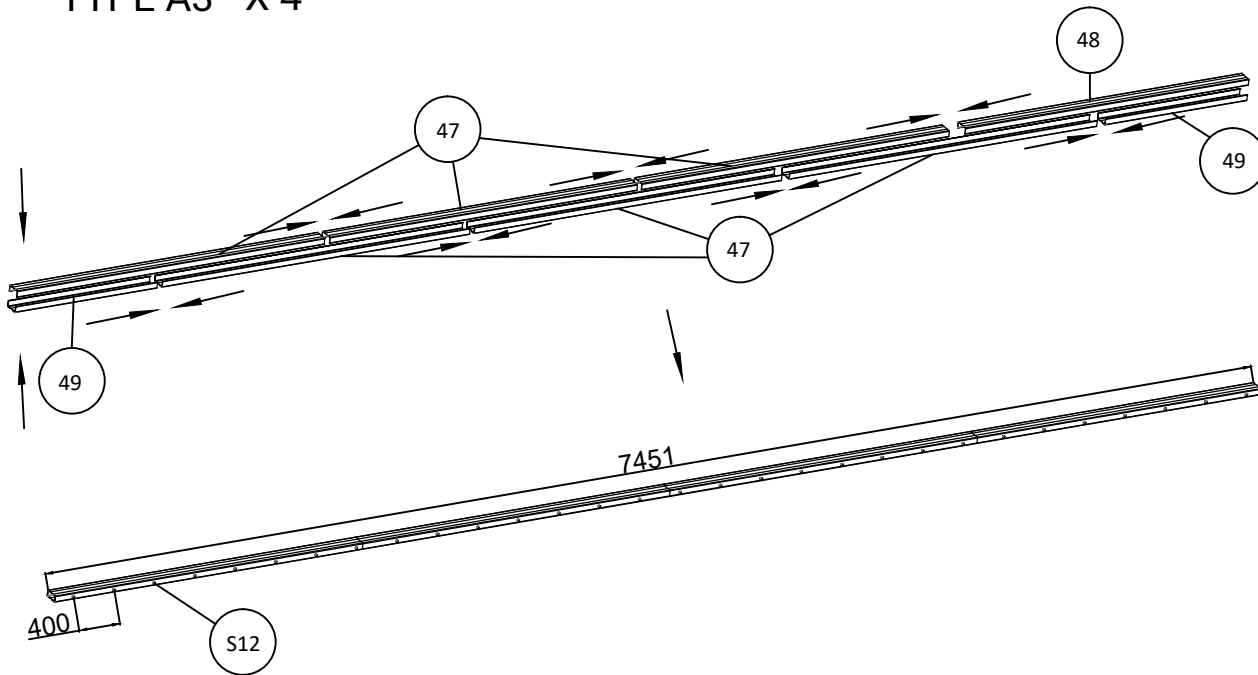
TYPE A3 X 4





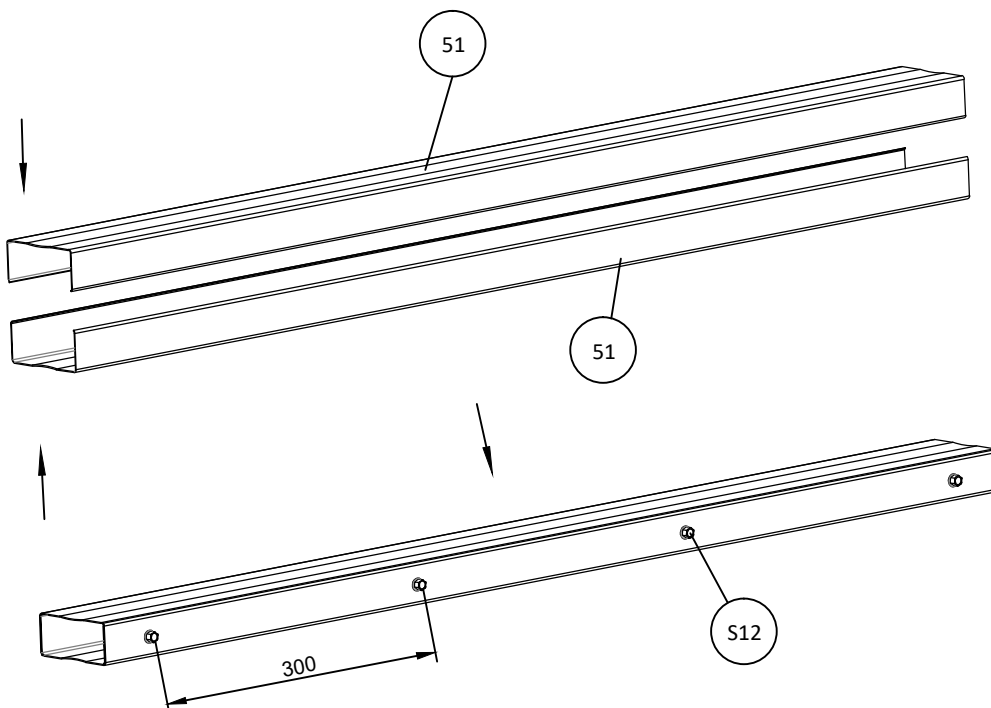

PART	NO.	Qty	PART	NO.	Qty
	51	2		S12	8

X4

TYPE A4 X 4





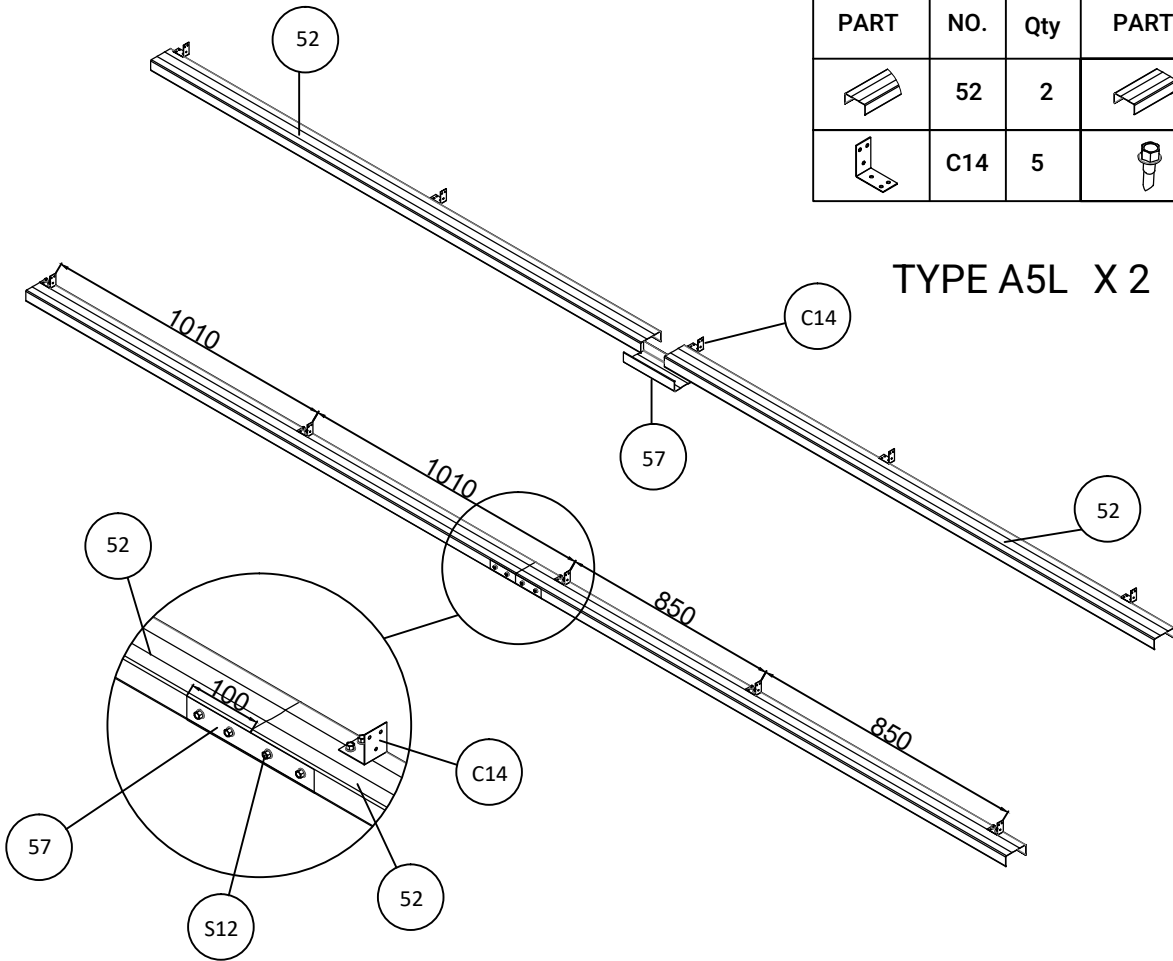

INSTALLATION OF FRAMEWORK

PART	NO.	Qty	PART	NO.	Qty
	52	2		57	1
	C14	5		S12	23

X 2



TYPE A5L X 2



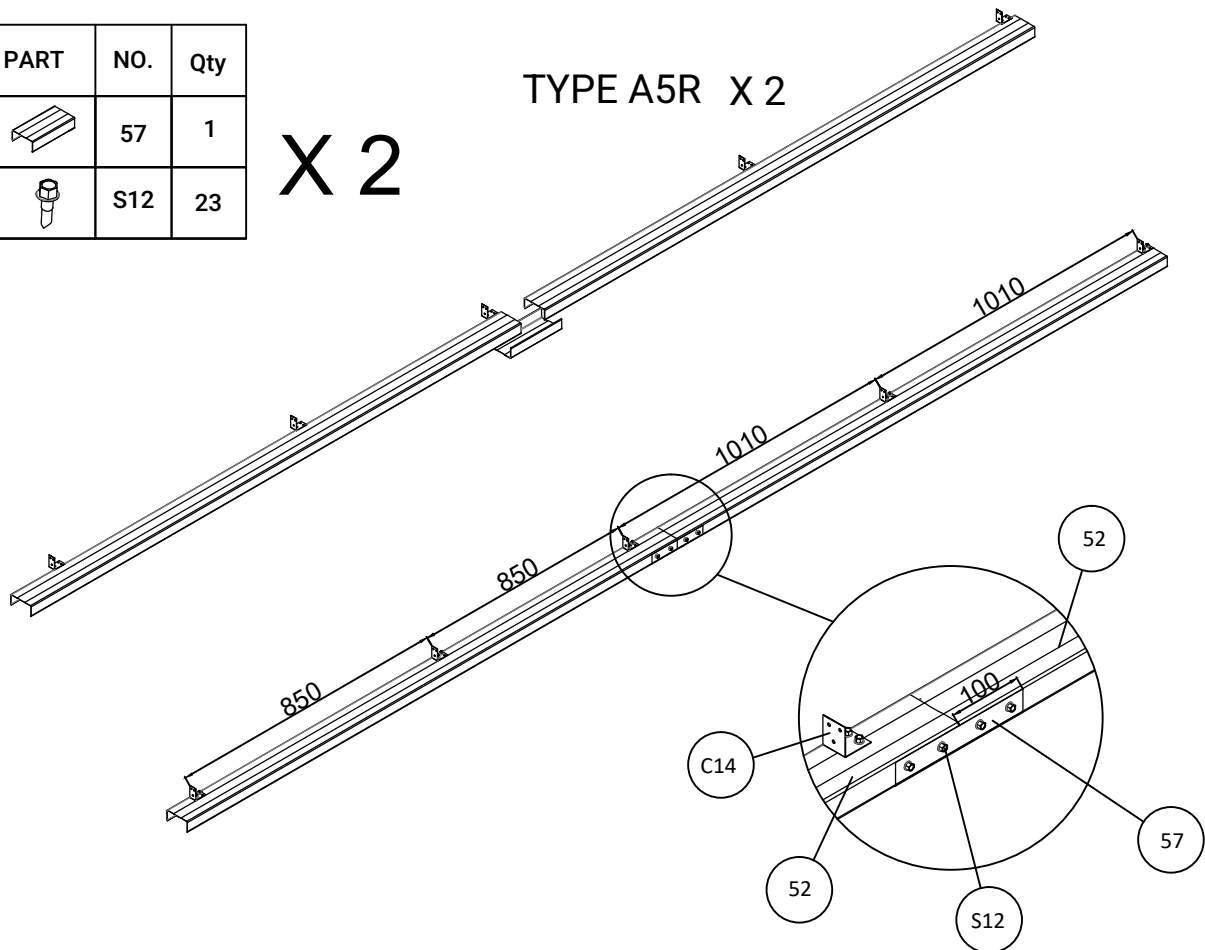

PART	NO.	Qty	PART	NO.	Qty
	52	2		57	1
	C14	5		S12	23

X 2

TYPE A5R X 2





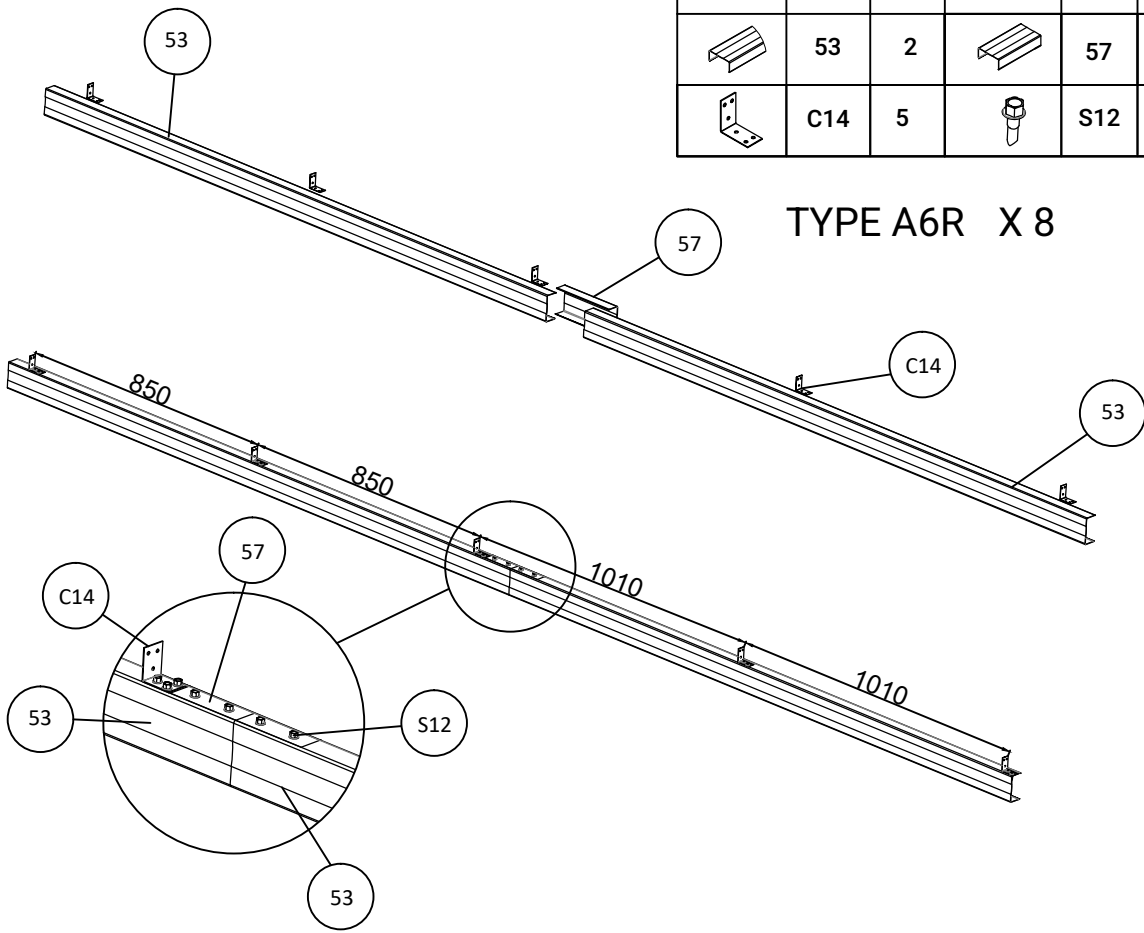

INSTALLATION OF FRAMEWORK

PART	NO.	Qty	PART	NO.	Qty
	53	2		57	1
	C14	5		S12	23

X 8



TYPE A6R X 8



PART	NO.	Qty	PART	NO.	Qty
	53	2		57	1
	C14	5		S12	23

X 8

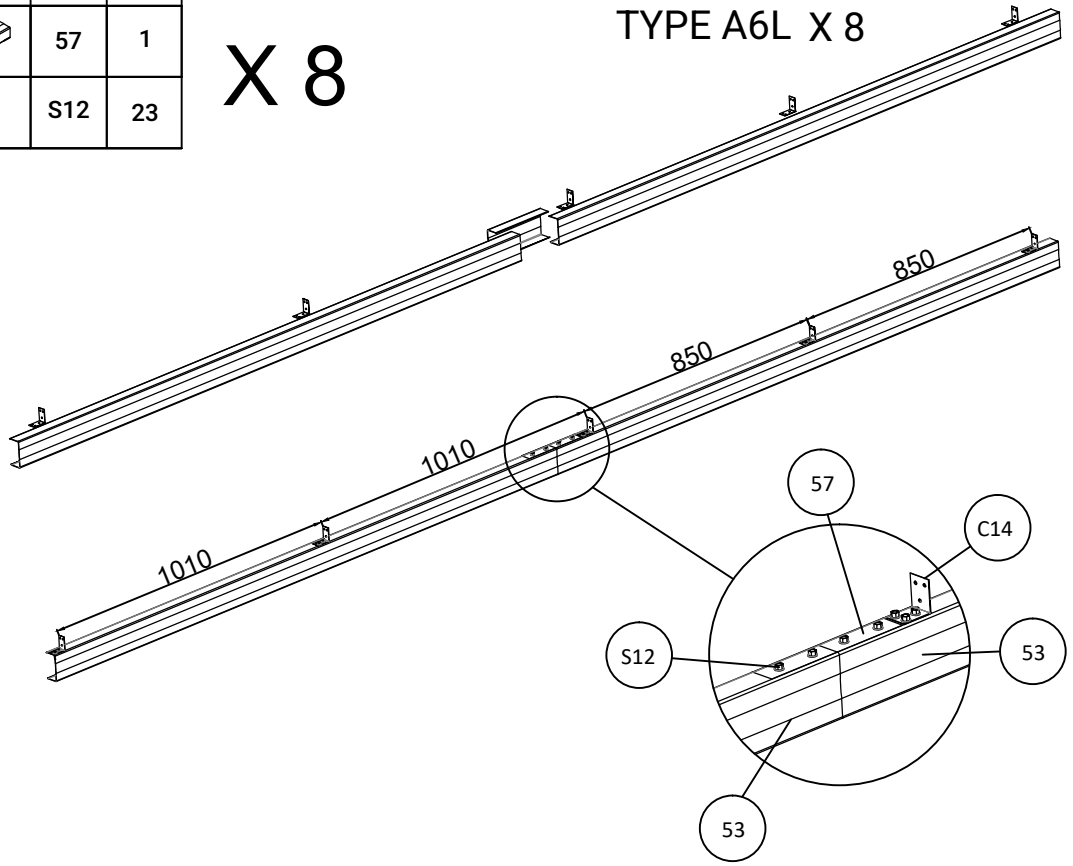
TYPE A6L X 8





INSTALLATION OF FRAMEWORK

PART	NO.	Qty	PART	NO.	Qty	PART	NO.	Qty
	56	1		57	1		S12	4

X 40

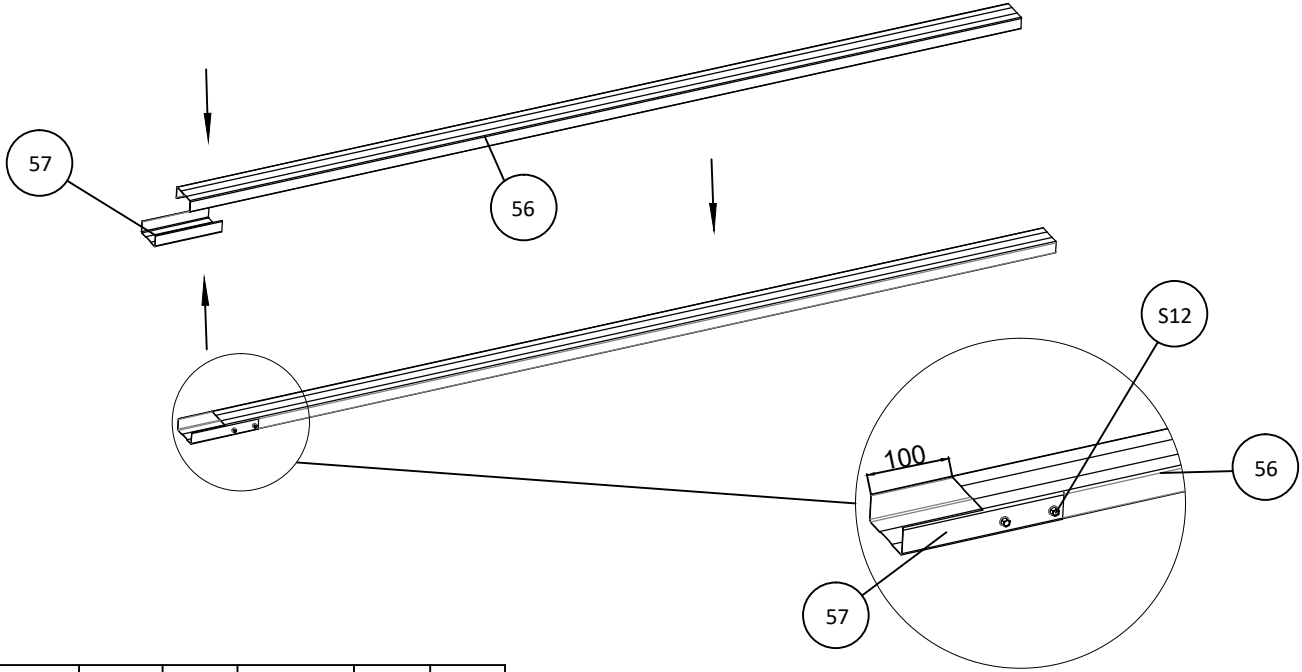
TYPE A7 X 40





PART	NO.	Qty	PART	NO.	Qty
	54	2		S12	12

X 8

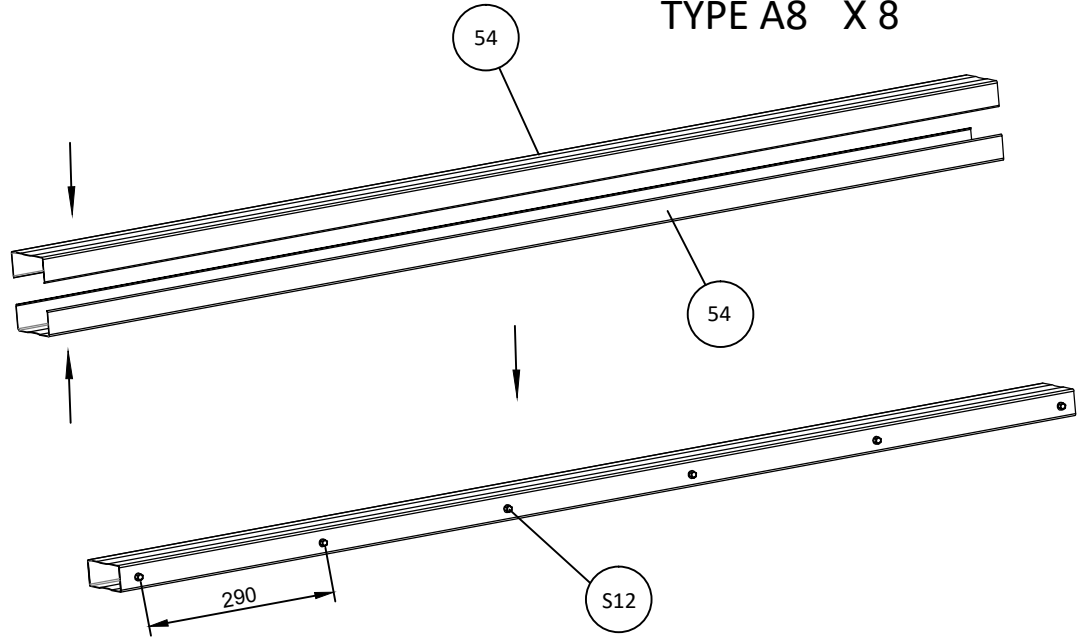
TYPE A8 X 8



INSTALLATION OF FRAMEWORK

PART	NO.	Qty	PART	NO.	Qty
	55	2		S12	6



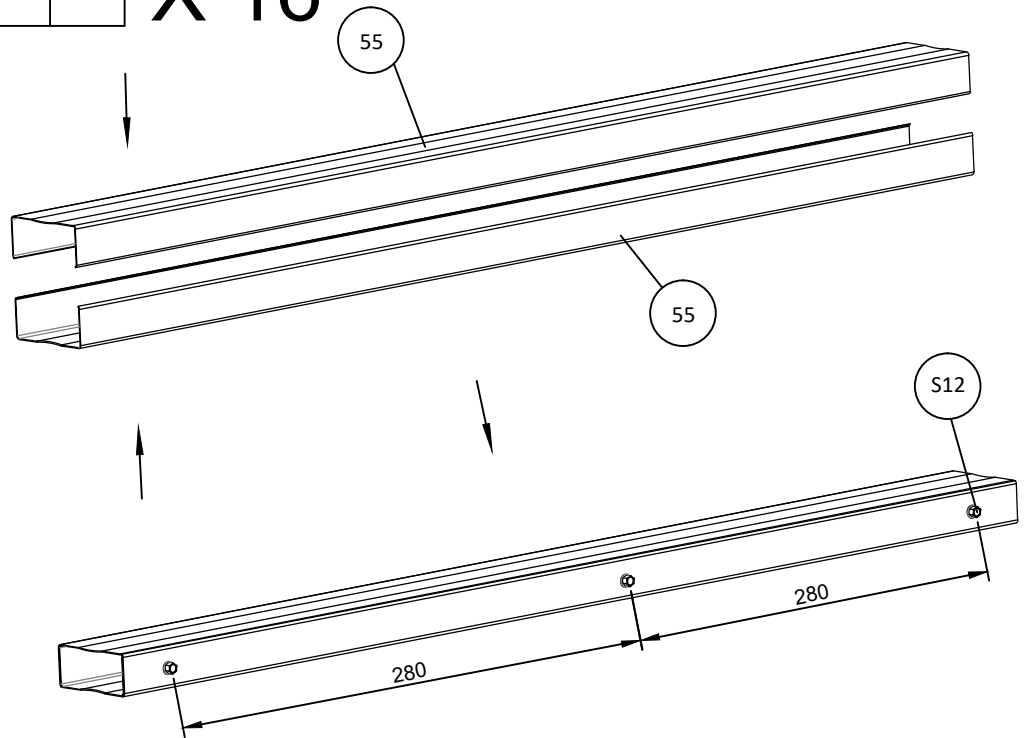

X 16

TYPE A9 X 16





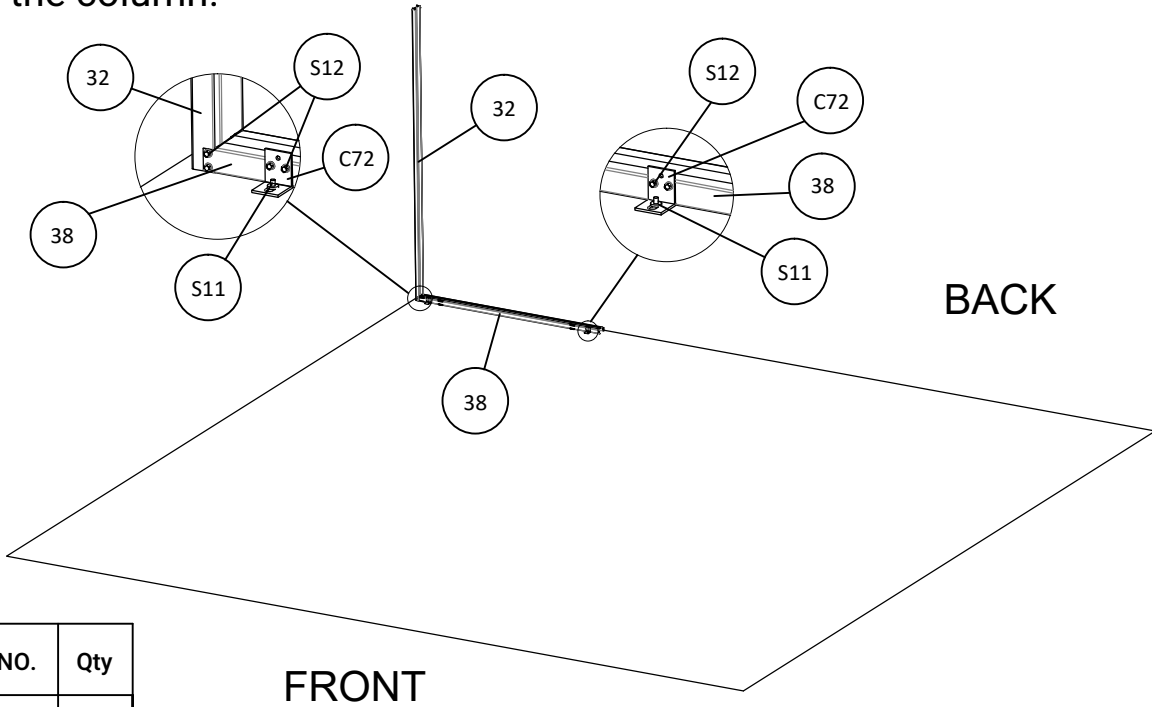

INSTALLATION OF FRAMEWORK

As shown in the figure draw a line before installation.
 Note:
 Please install the grounding part on the cement block near the column.





PART	NO.	Qty	PART	NO.	Qty	PART	NO.	Qty
	32	1		38	1		C72	2
	S12	8		S11	2			

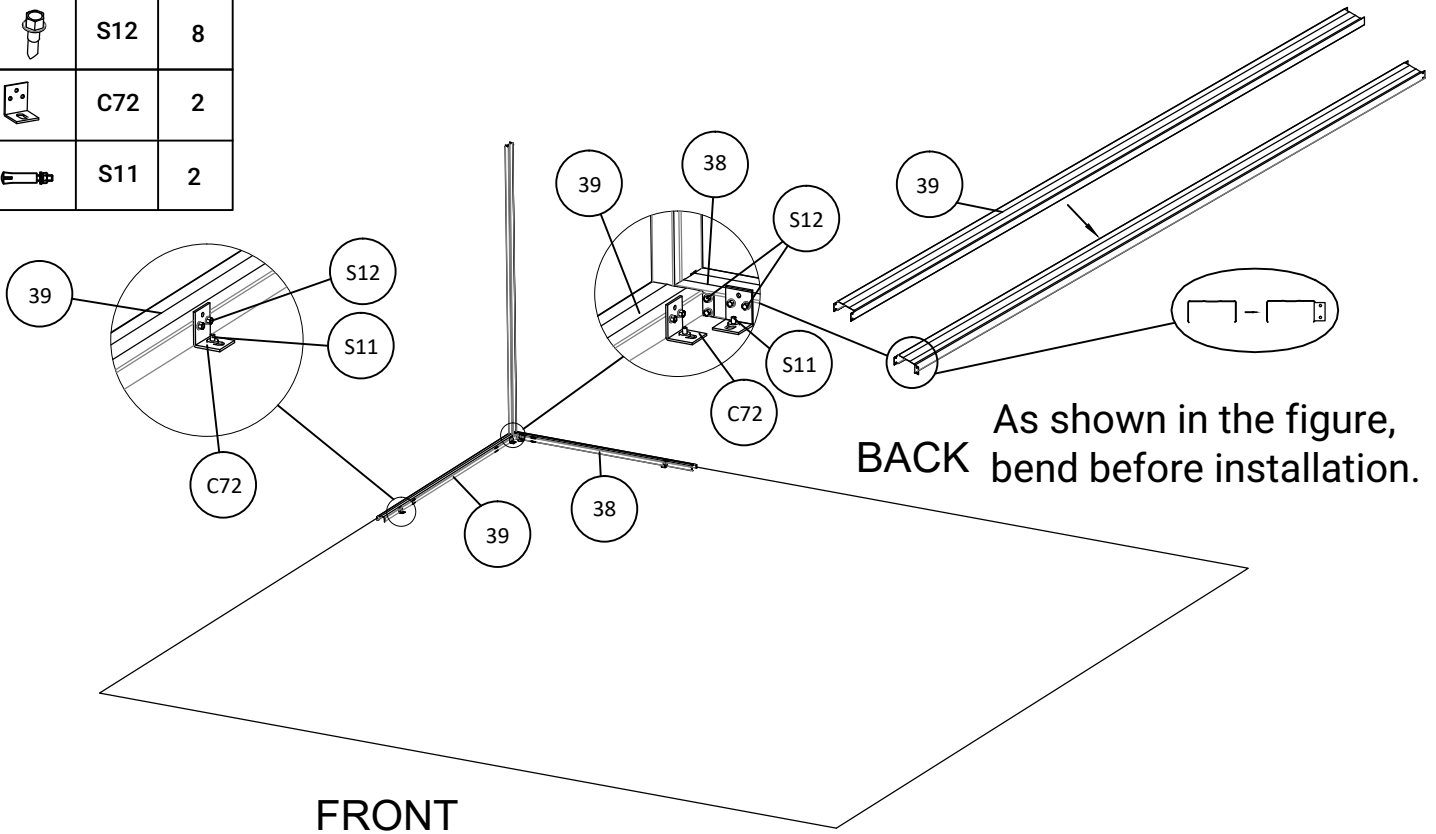







PART	NO.	Qty
	39	1
	S12	8
	C72	2
	S11	2

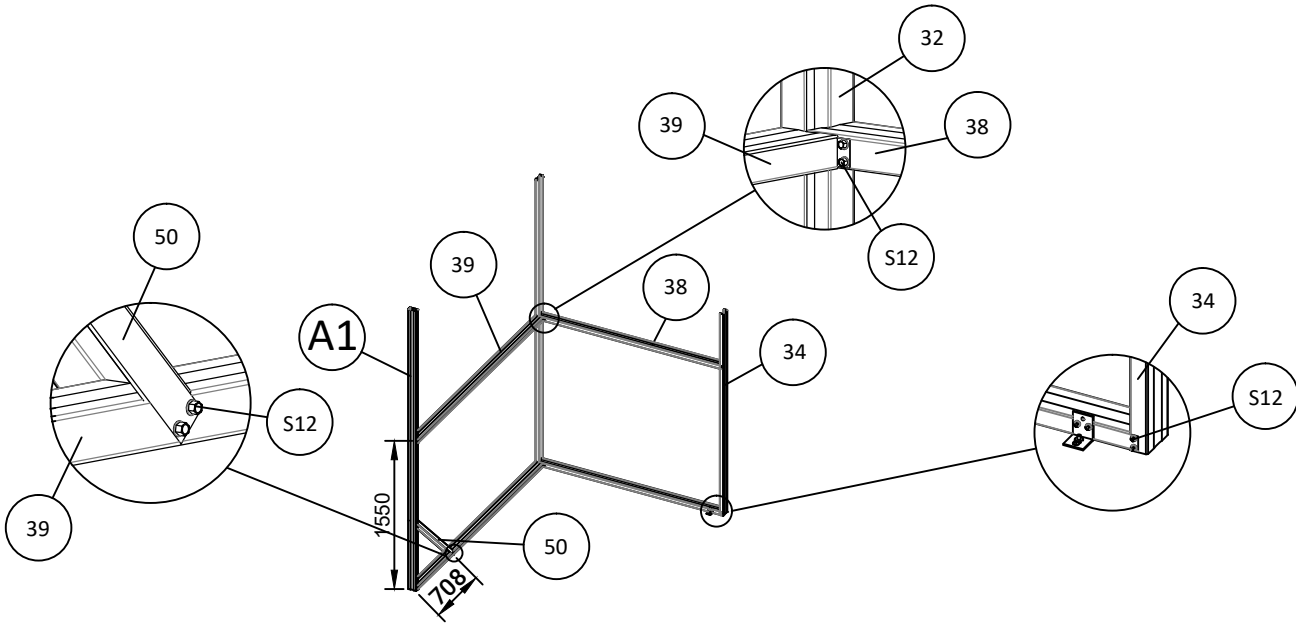

INSTALLATION OF FRAMEWORK

PART	NO.	Qty	PART	NO.	Qty	PART	NO.	Qty	PART	NO.	Qty	PART	NO.	Qty
	39	1		38	1		34	1		50	1		S12	32



PART	NO.	Qty	PART	NO.	Qty	PART	NO.	Qty	PART	NO.	Qty
	38	6		34	2		32	1		S12	56
	C72	4		S11	4						

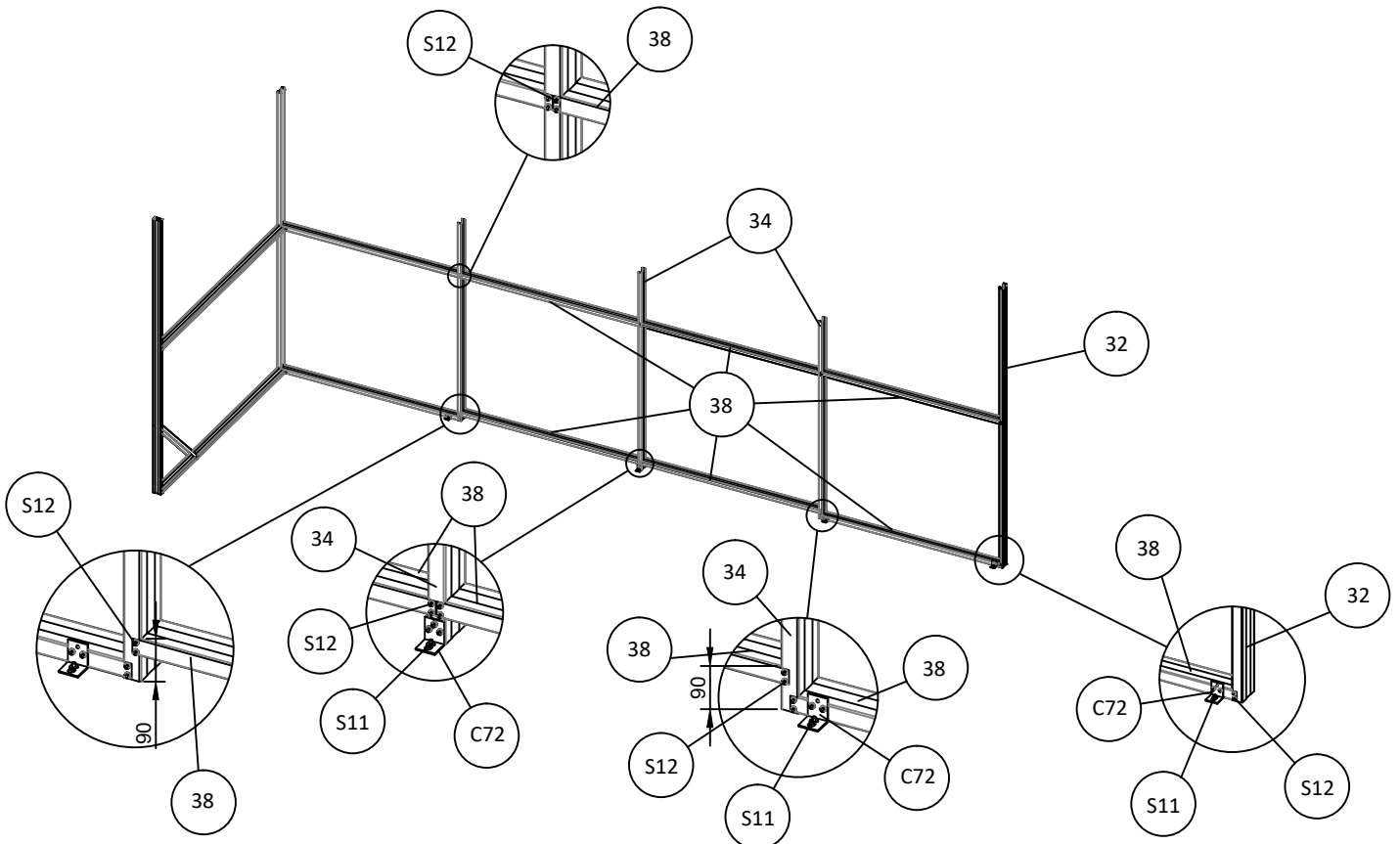

INSTALLATION OF FRAMEWORK

PART	NO.	Qty	PART	NO.	Qty	PART	NO.	Qty	PART	NO.	Qty	PART	NO.	Qty
	39	3		38	4		35	2		36	1		37	2
	50	3		42	1		41	1		43	1		57	3
	S11	2		C72	2		S12	152						

TIPS: If you want to change the door position to the opposite wall, please refer to page p50-51.

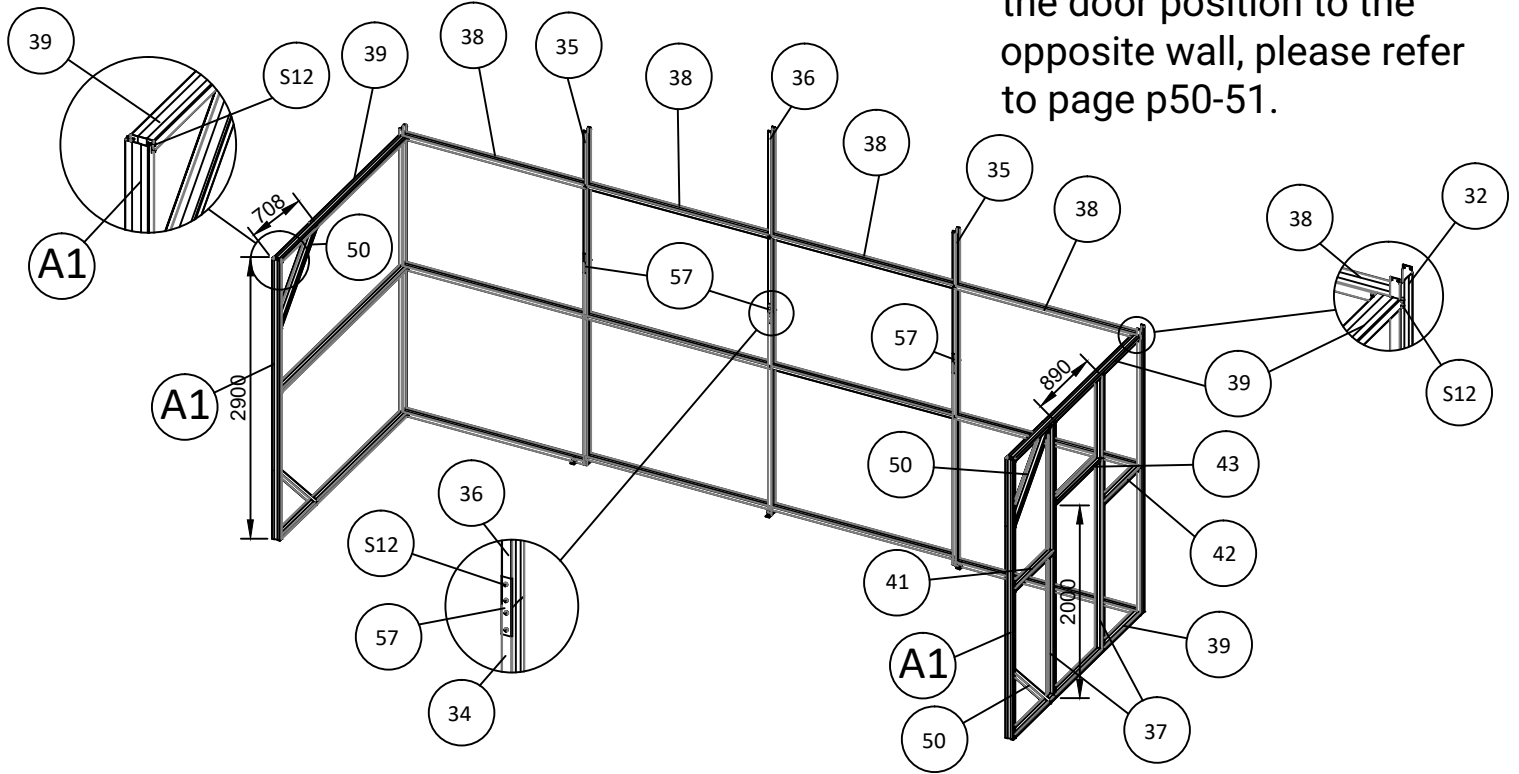

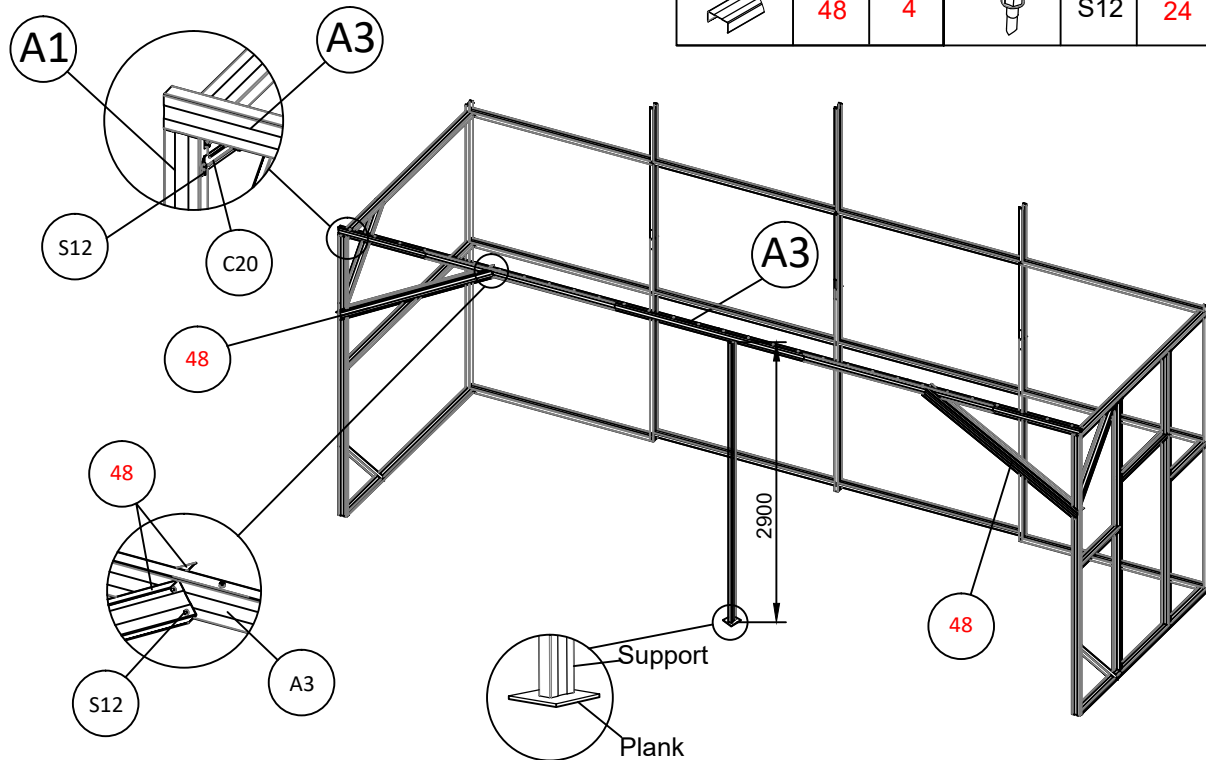

PART	NO.	Qty	PART	NO.	Qty	PART	NO.	Qty
	48	4		S12	24		C20	2



As shown in the figure, when installing A3, support it with an object with a length of 2900mm to prevent it from falling and deformation. Other parts can be used temporarily. If the ground is not hardened, please put a board under the support to make it level with the foundation.

INSTALLATION OF FRAMEWORK

PART	NO.	Qty	PART	NO.	Qty
	C73	4		S12	40

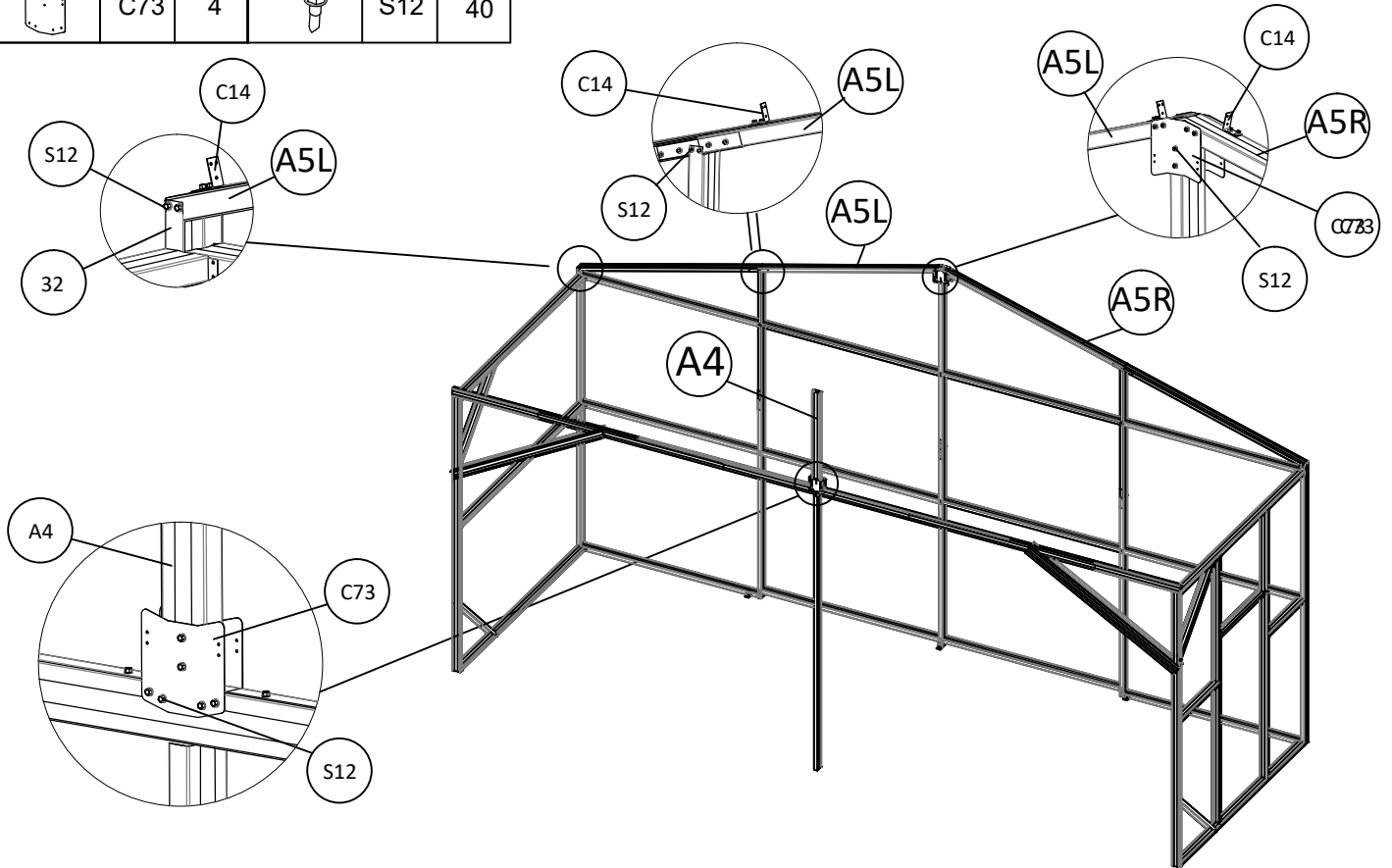

PART	NO.	Qty
	S12	4

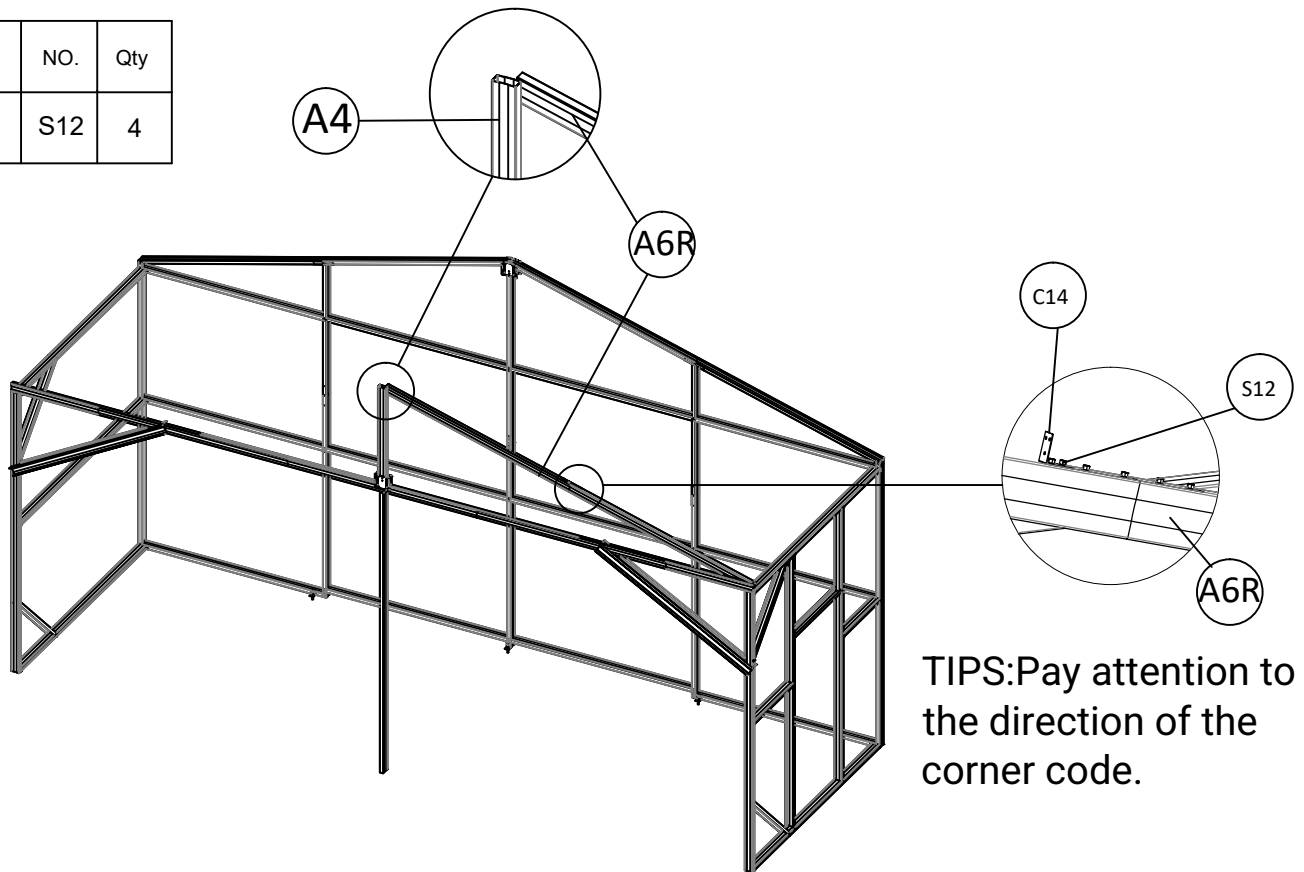



TIPS: Pay attention to the direction of the corner code.

INSTALLATION OF FRAMEWORK

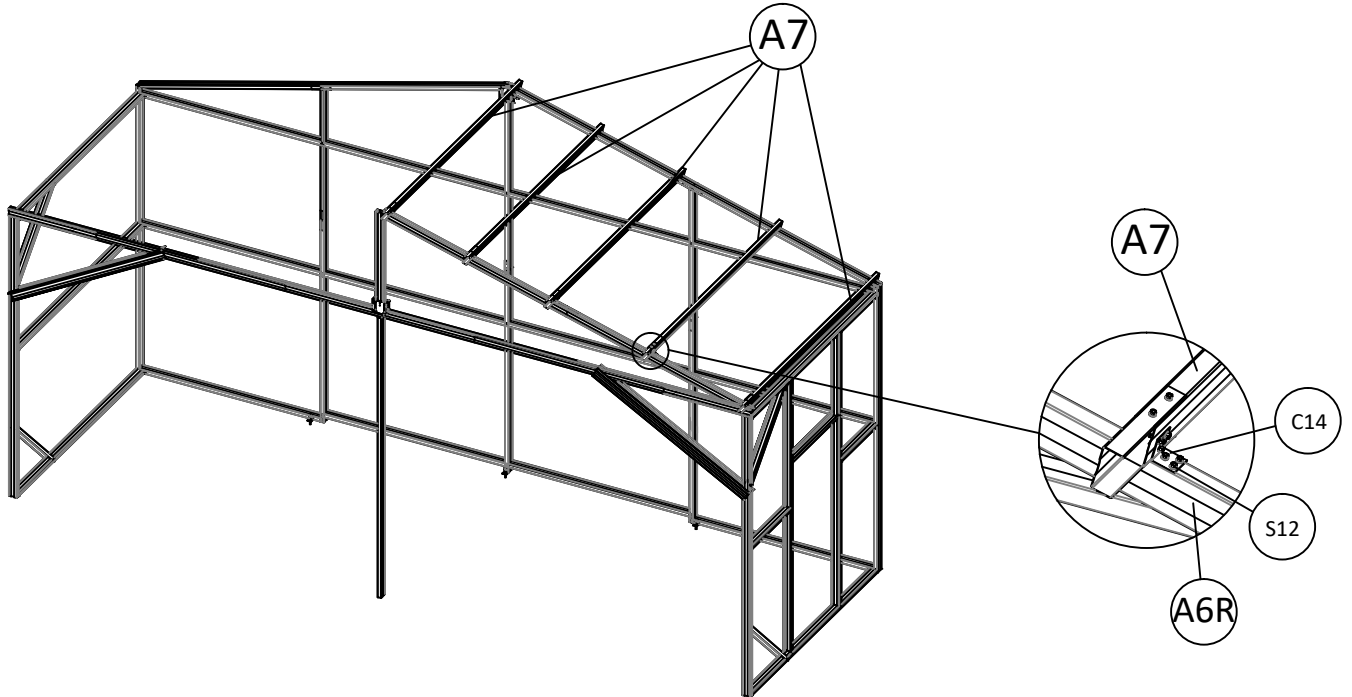
PART	NO.	Qty
	S12	30



PART	NO.	Qty	PART	NO.	Qty
	S12	42		58	2

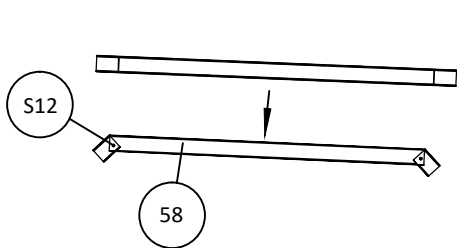

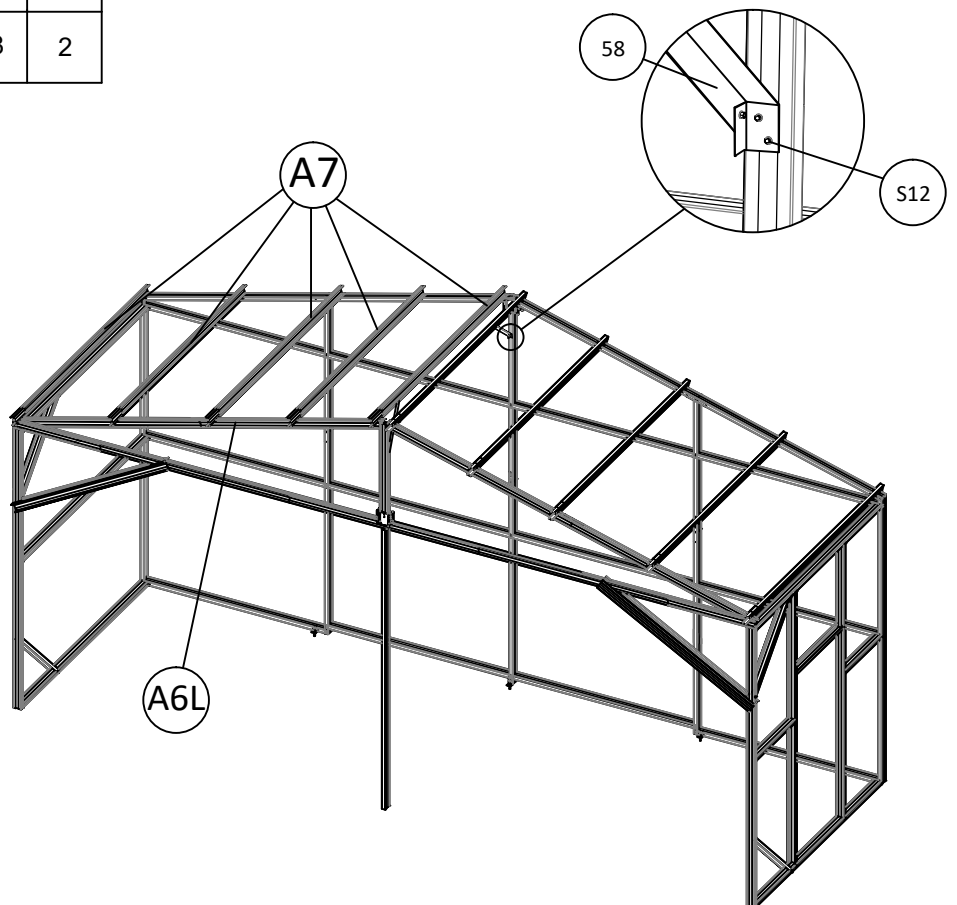

Note: please bend the 58 to a proper angle at the notch before installation.



INSTALLATION OF FRAMEWORK

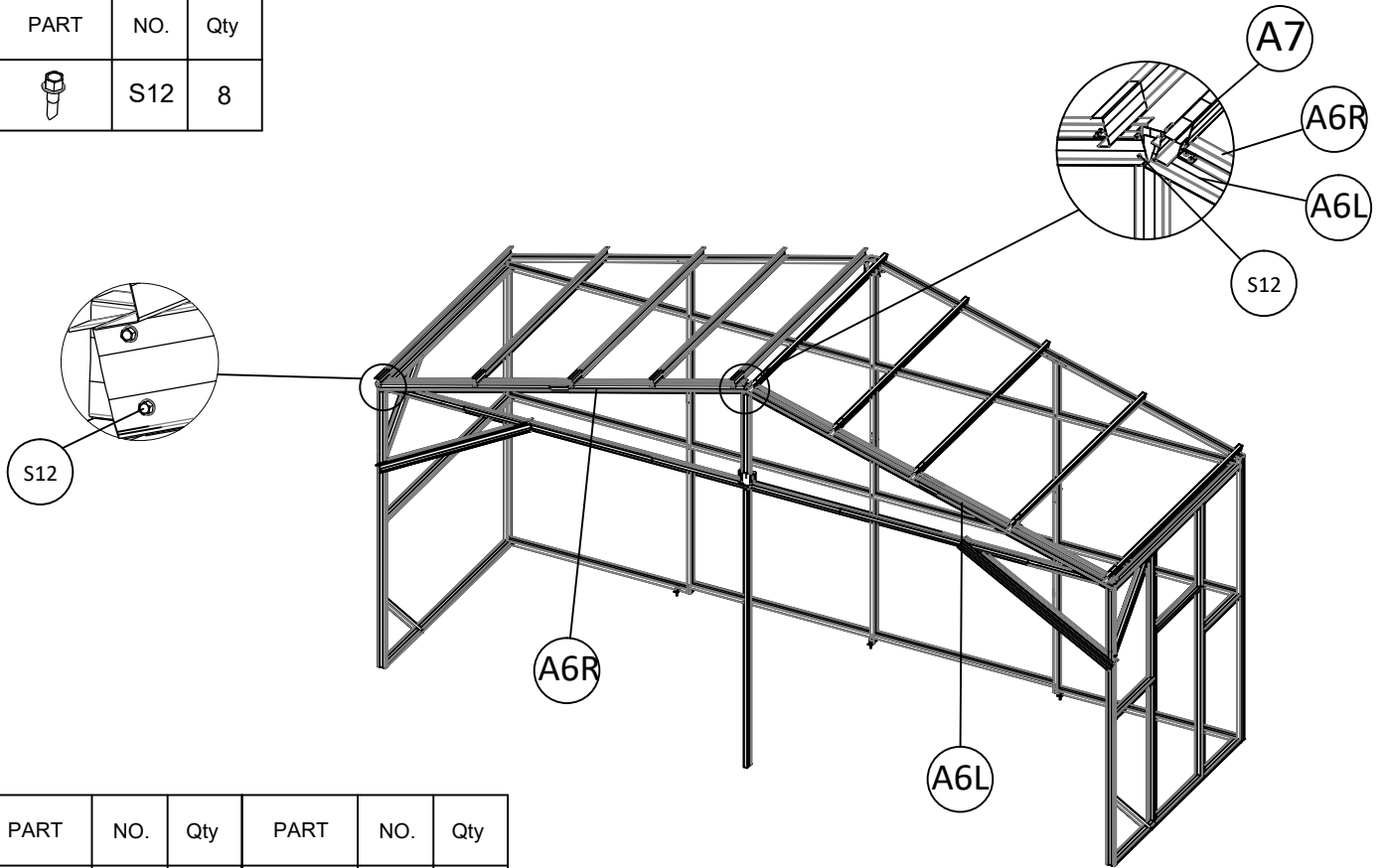



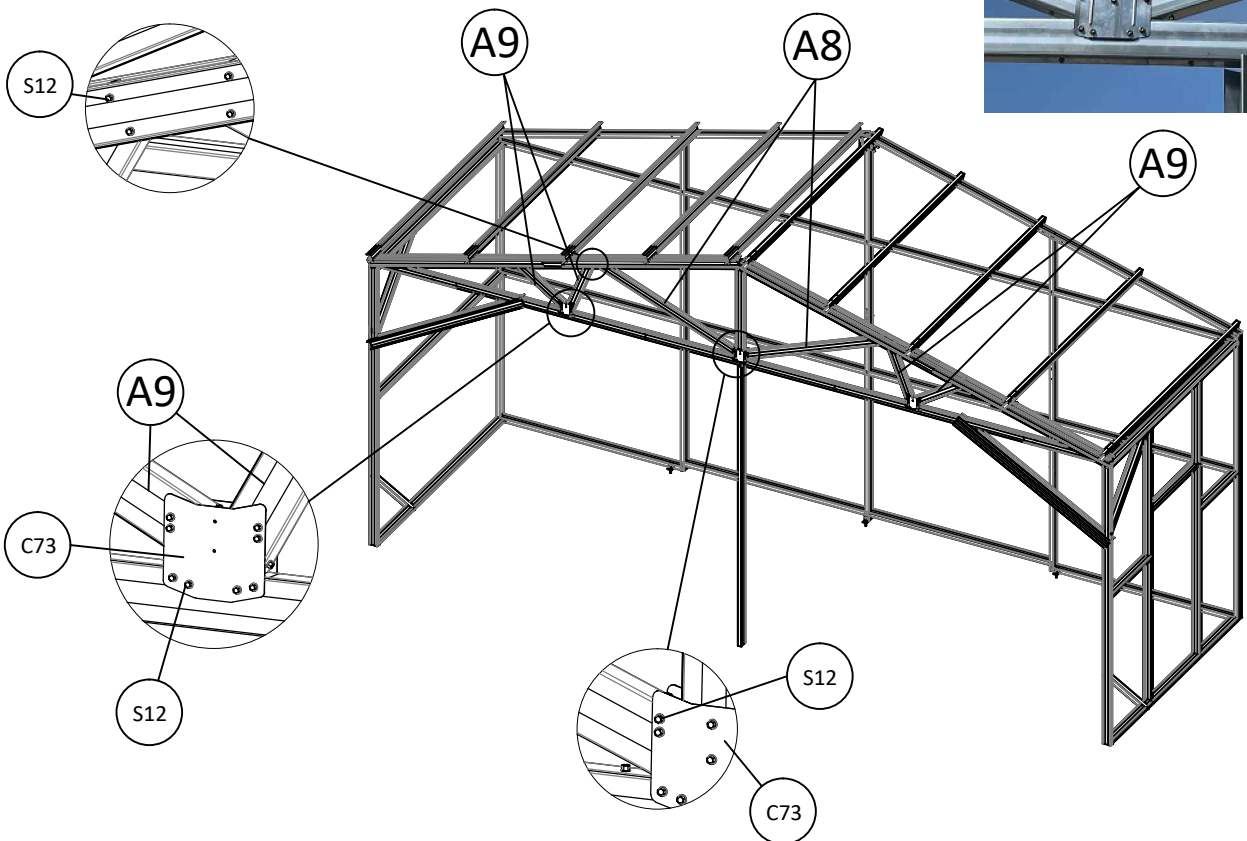

PART	NO.	Qty
	S12	8







PART	NO.	Qty	PART	NO.	Qty
	C73	4		S12	64

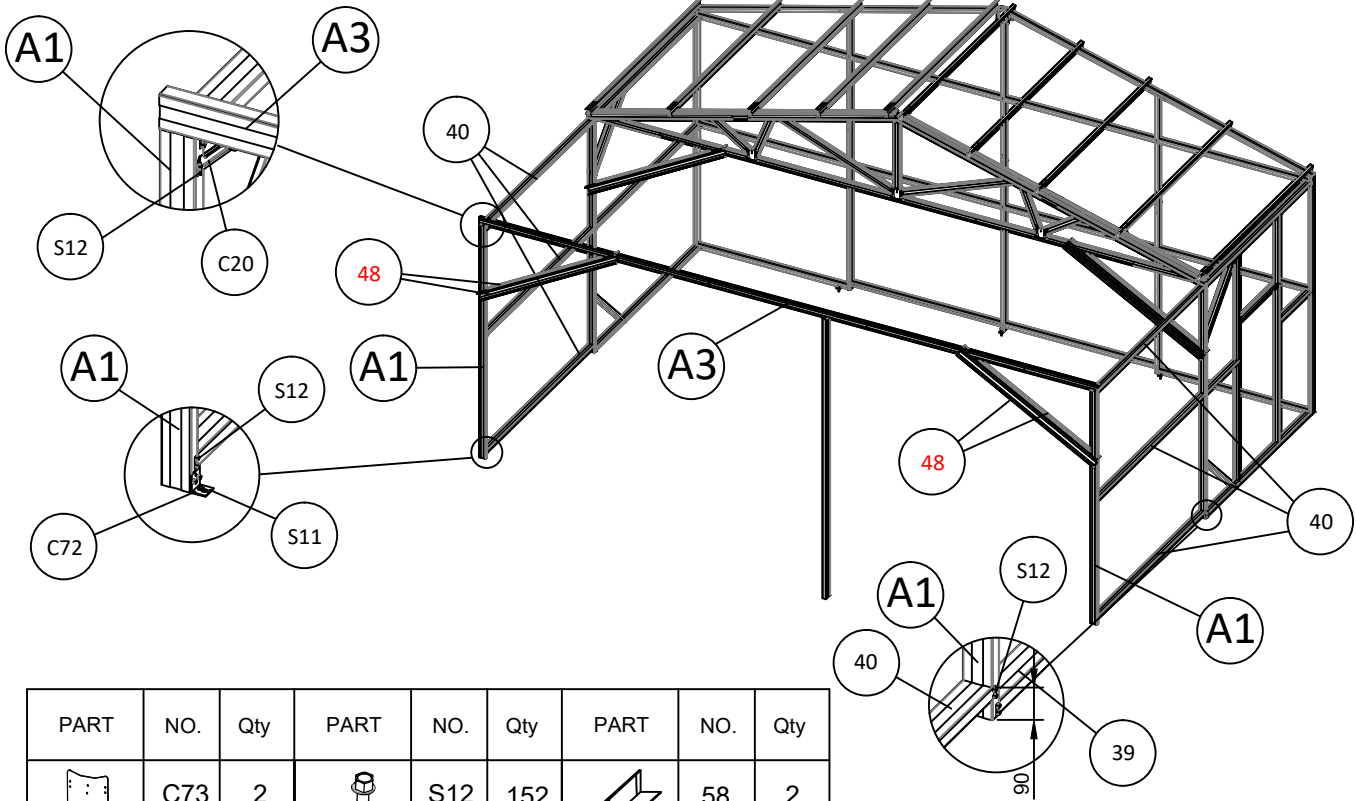

INSTALLATION OF FRAMEWORK

PART	NO.	Qty	PART	NO.	Qty	PART	NO.	Qty	PART	NO.	Qty	PART	NO.	Qty
	40	6		48	4		S12	84		S11	2		C72	2
	C20	2	STEP ONE											



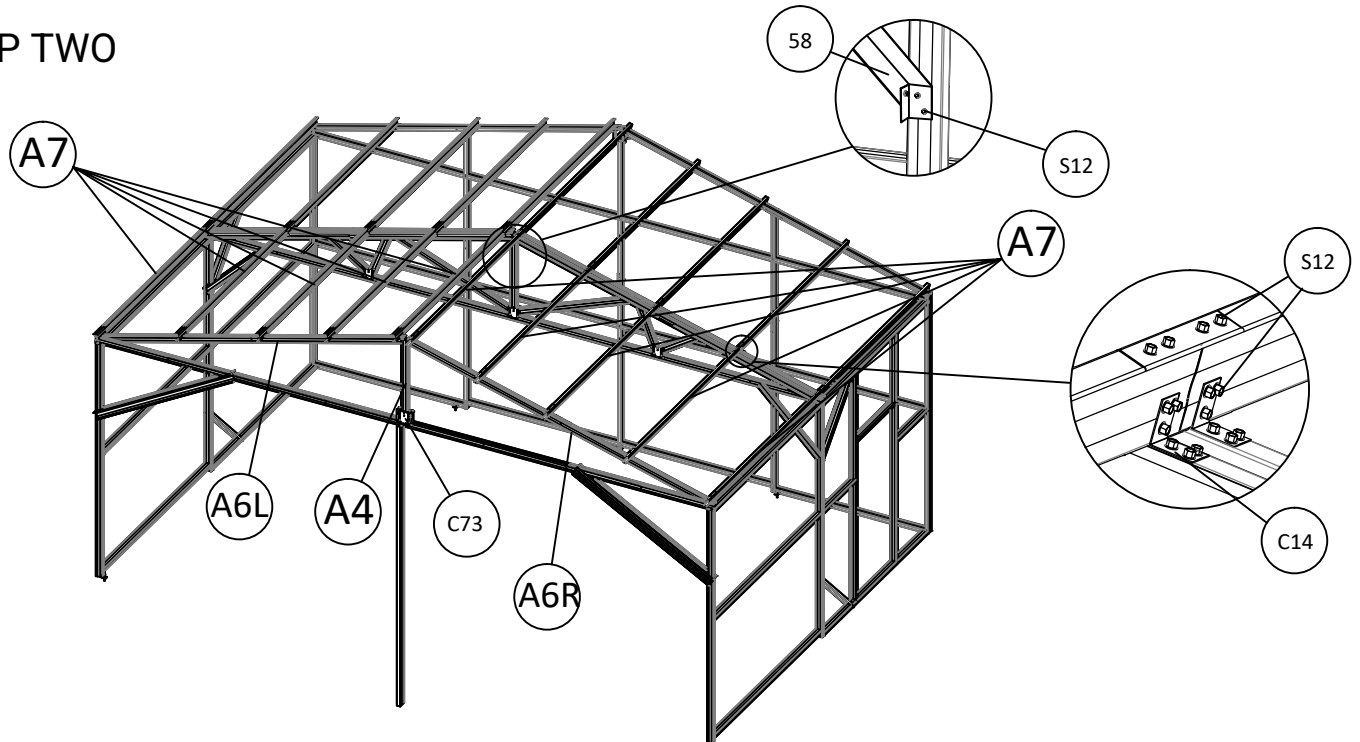

PART	NO.	Qty	PART	NO.	Qty	PART	NO.	Qty
	C73	2		S12	152		58	2

STEP TWO



INSTALLATION OF FRAMEWORK

PART	NO.	Qty	PART	NO.	Qty
	C73	4		S12	72

STEP THREE

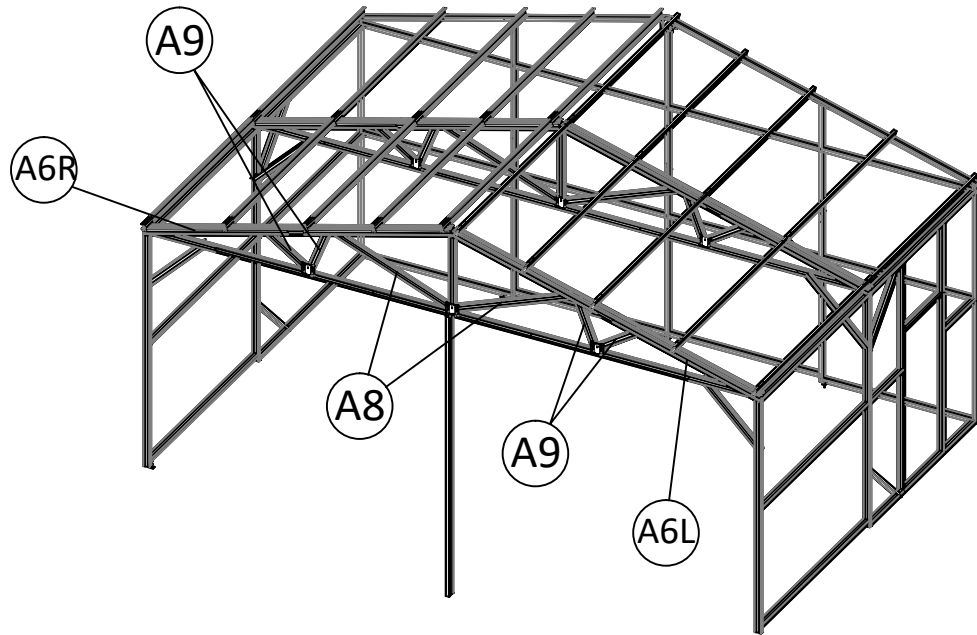





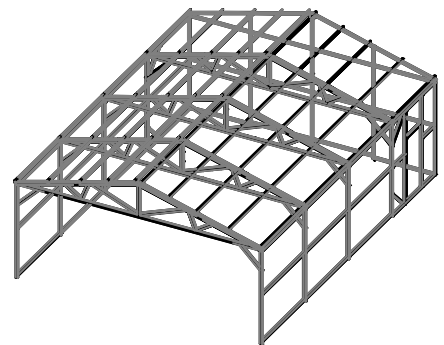





CG2541

Repeat STEP ONE to STEP THREE twice to complete CG2541.





INSTALLATION OF FRAMEWORK

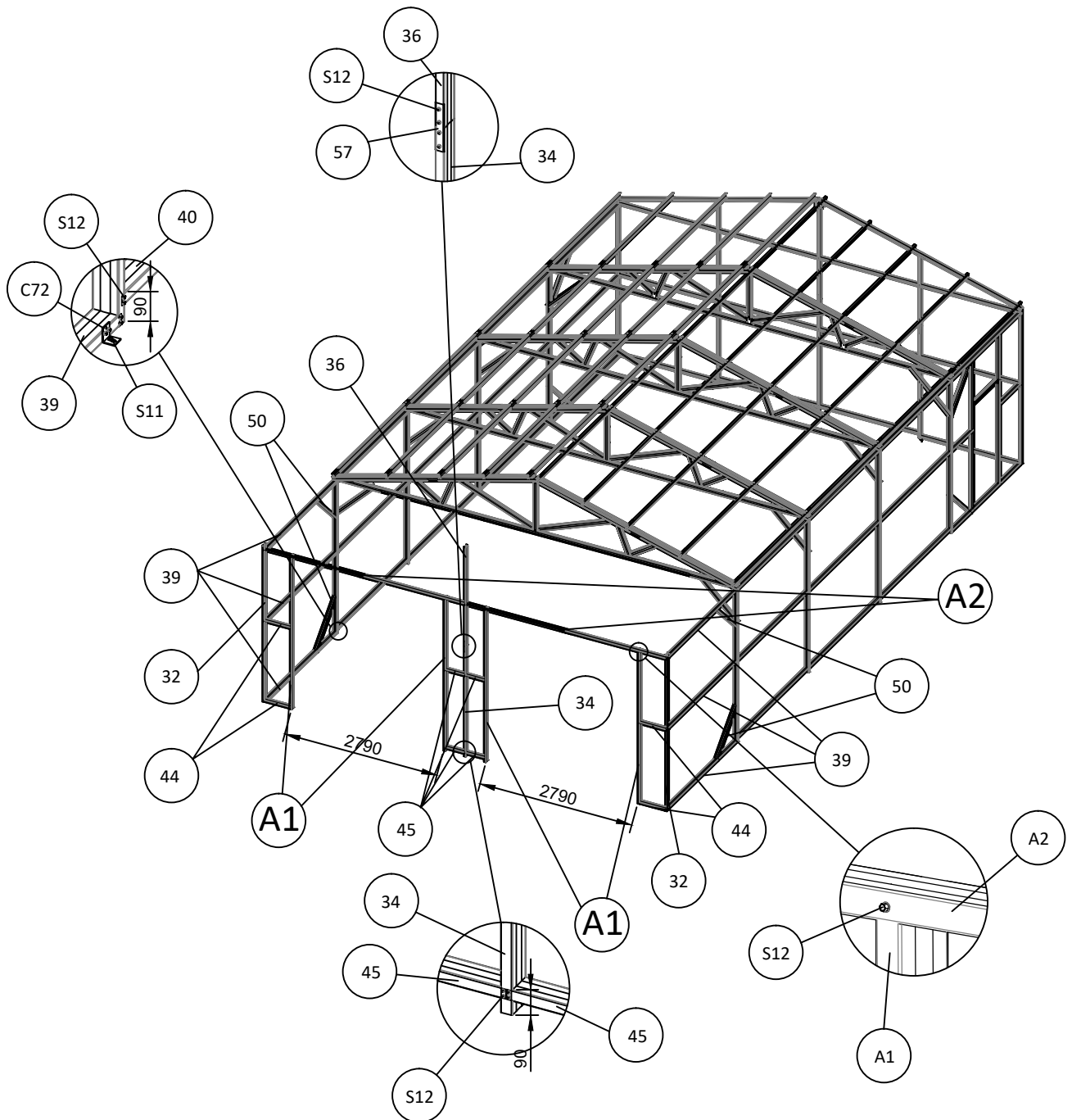

PART	NO.	Qty	PART	NO.	Qty	PART	NO.	Qty	PART	NO.	Qty	PART	NO.	Qty
	39	6		36	1		44	4		45	4		50	4
	34	1		32	2		57	1		S11	9		C72	9
	S12	194												



INSTALLATION OF FRAMEWORK

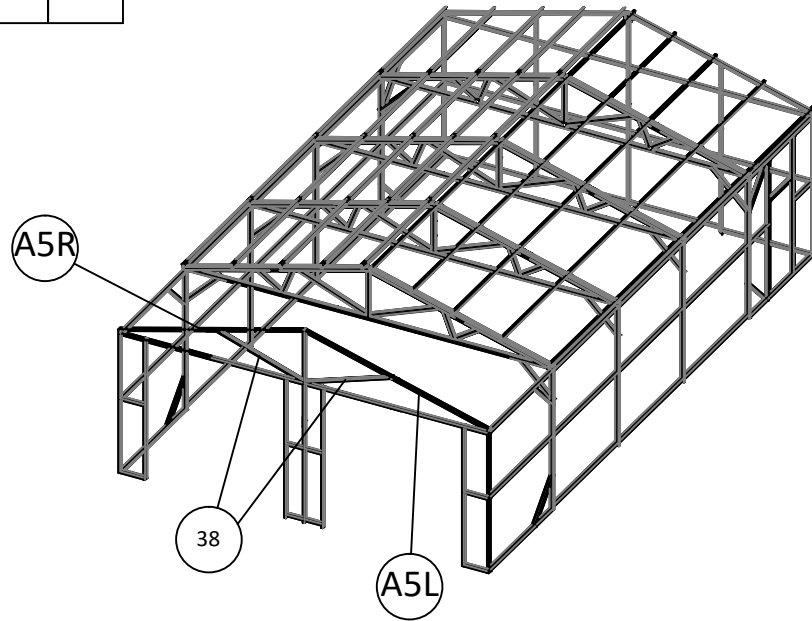

PART	NO.	Qty	PART	NO.	Qty
	38	2		S12	16

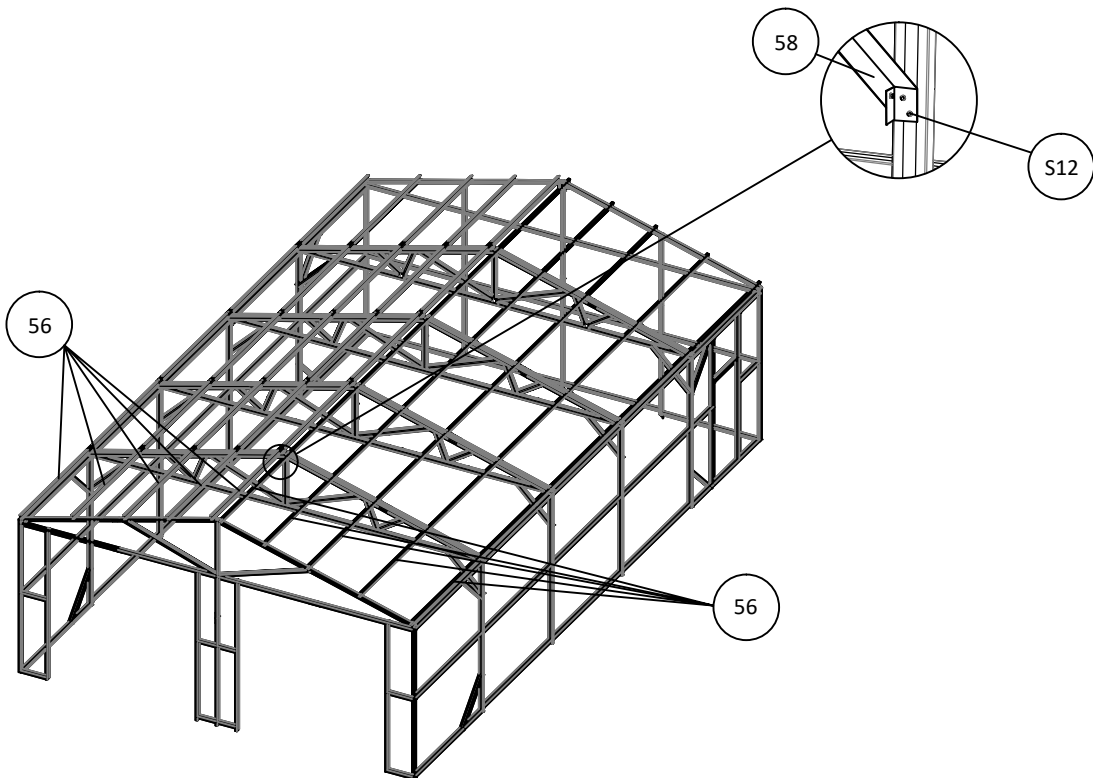

PART	NO.	Qty	PART	NO.	Qty	PART	NO.	Qty
	56	10		S12	72		58	2



INSTALLATION OF FRAMEWORK

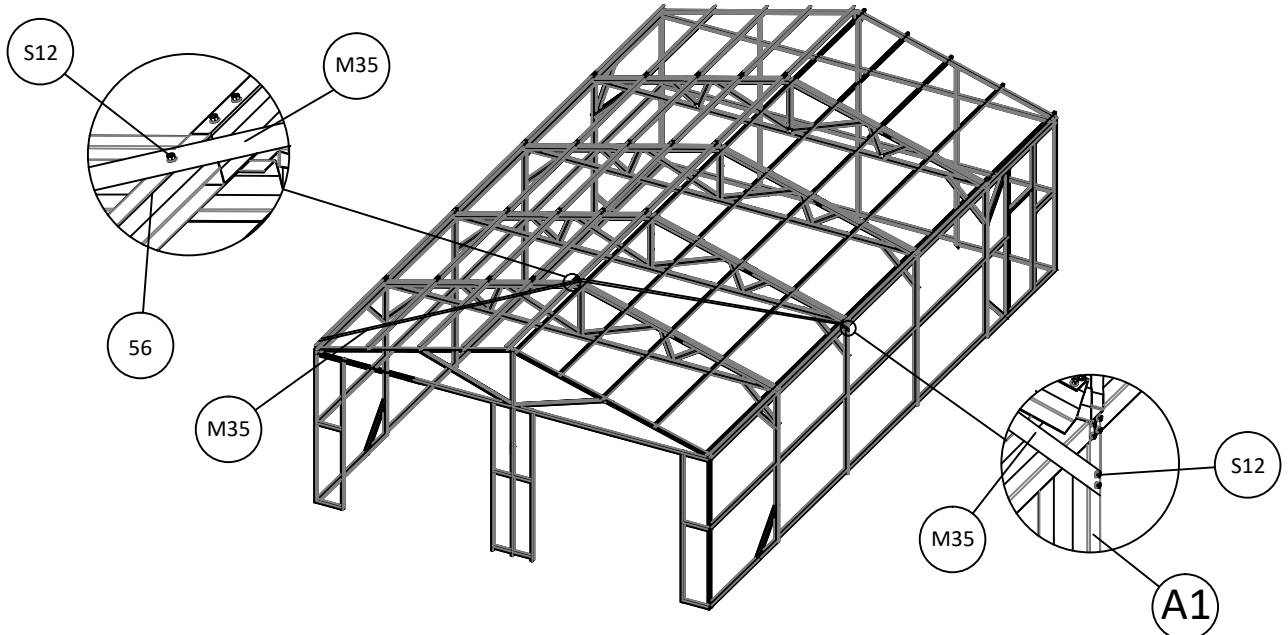

PART	NO.	Qty	PART	NO.	Qty
	M35	4		S12	24

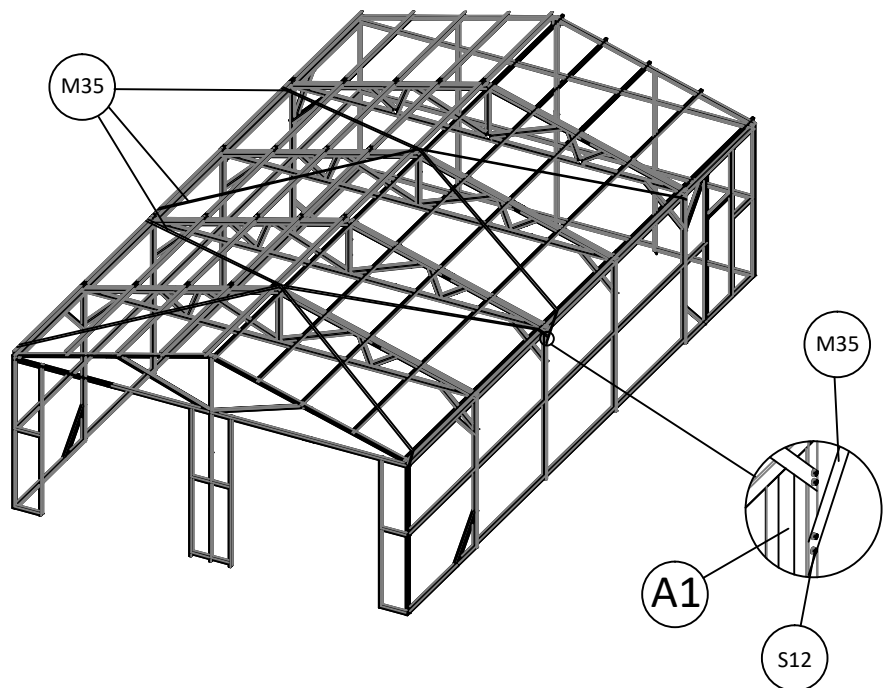

As shown in the figure, M35 diagonal is used to fix every two spans of the row to increase the overall strength. During installation, fix one end of M35 on the column, tighten it from the top of the roof to the other side, and fix it on the column on the other side. After fixing, please cut the excess part to an appropriate length. (please align the frame before installation)





INSTALLATION OF WALL TILE

PART	NO.	Qty	PART	NO.	Qty
	1	9		S12	36

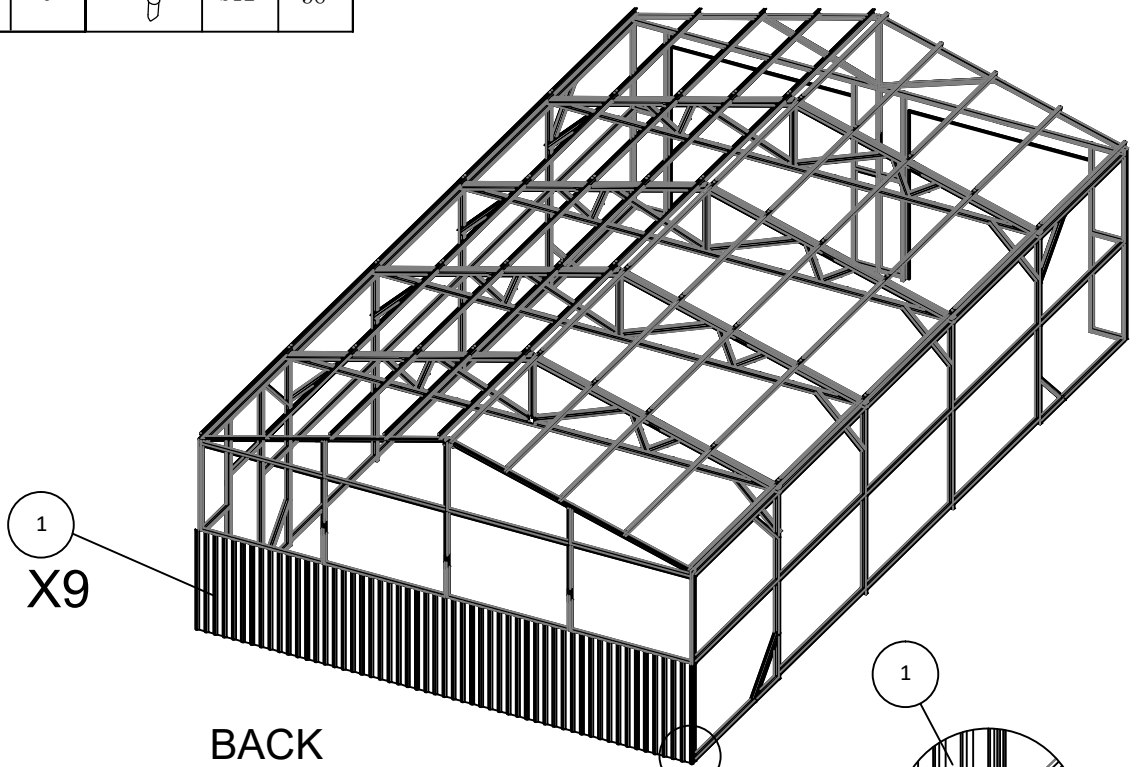
FRONT







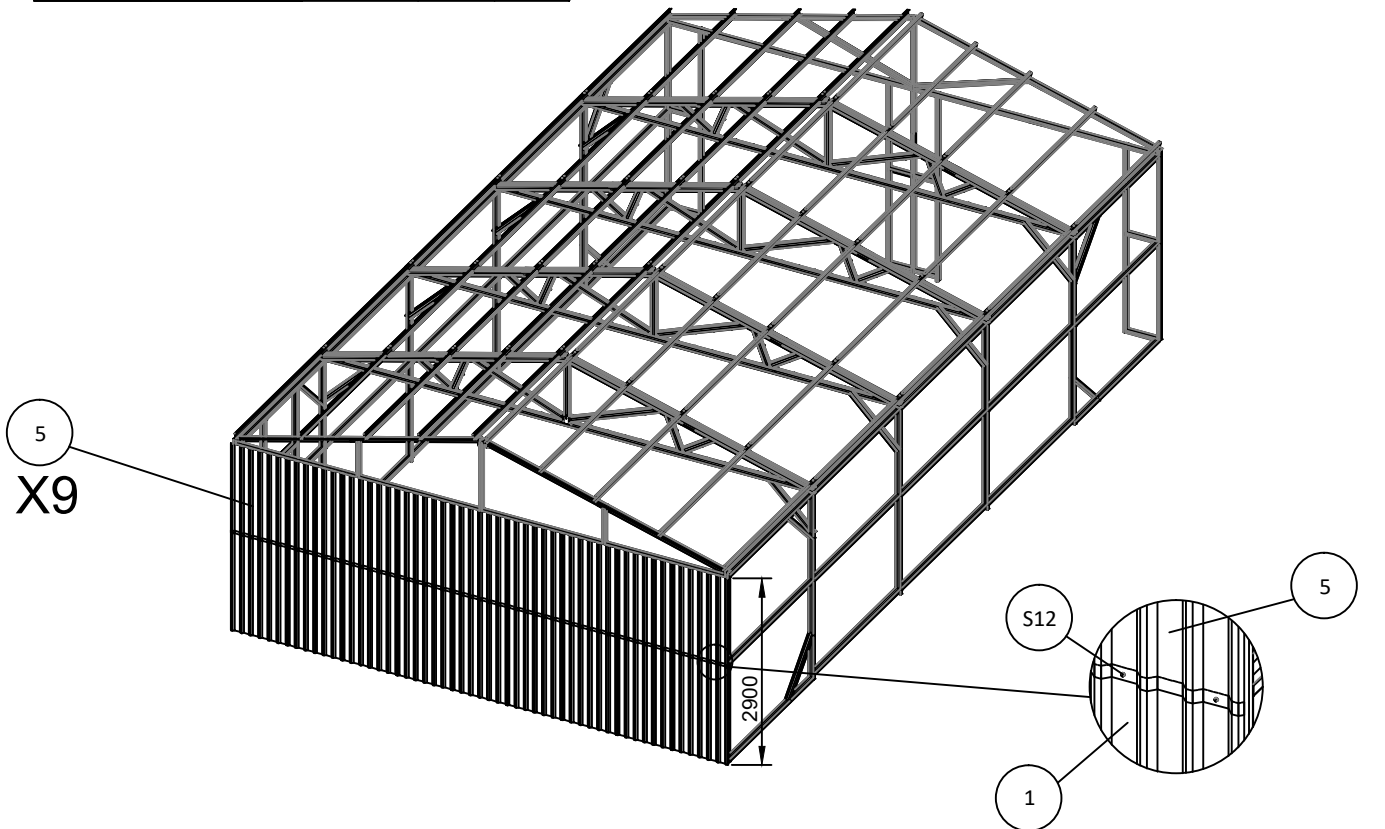





BACK



PART	NO.	Qty	PART	NO.	Qty
	5	9		S12	36

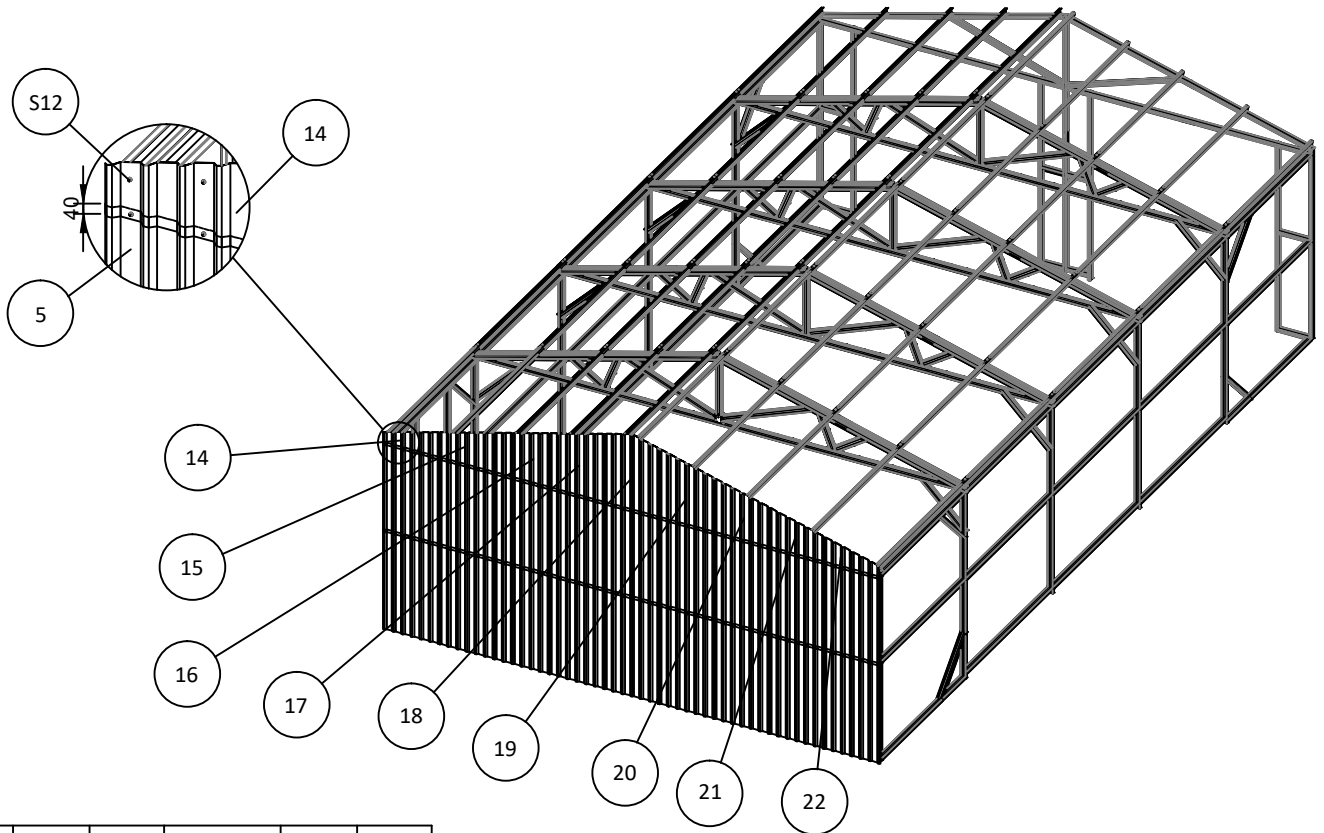

INSTALLATION OF WALL TILE

PART	NO.	Qty	PART	NO.	Qty	PART	NO.	Qty	PART	NO.	Qty	PART	NO.	Qty
	S12	72		14	1		15	1		16	1		17	1
	18	1		22	1		21	1		20	1		19	1



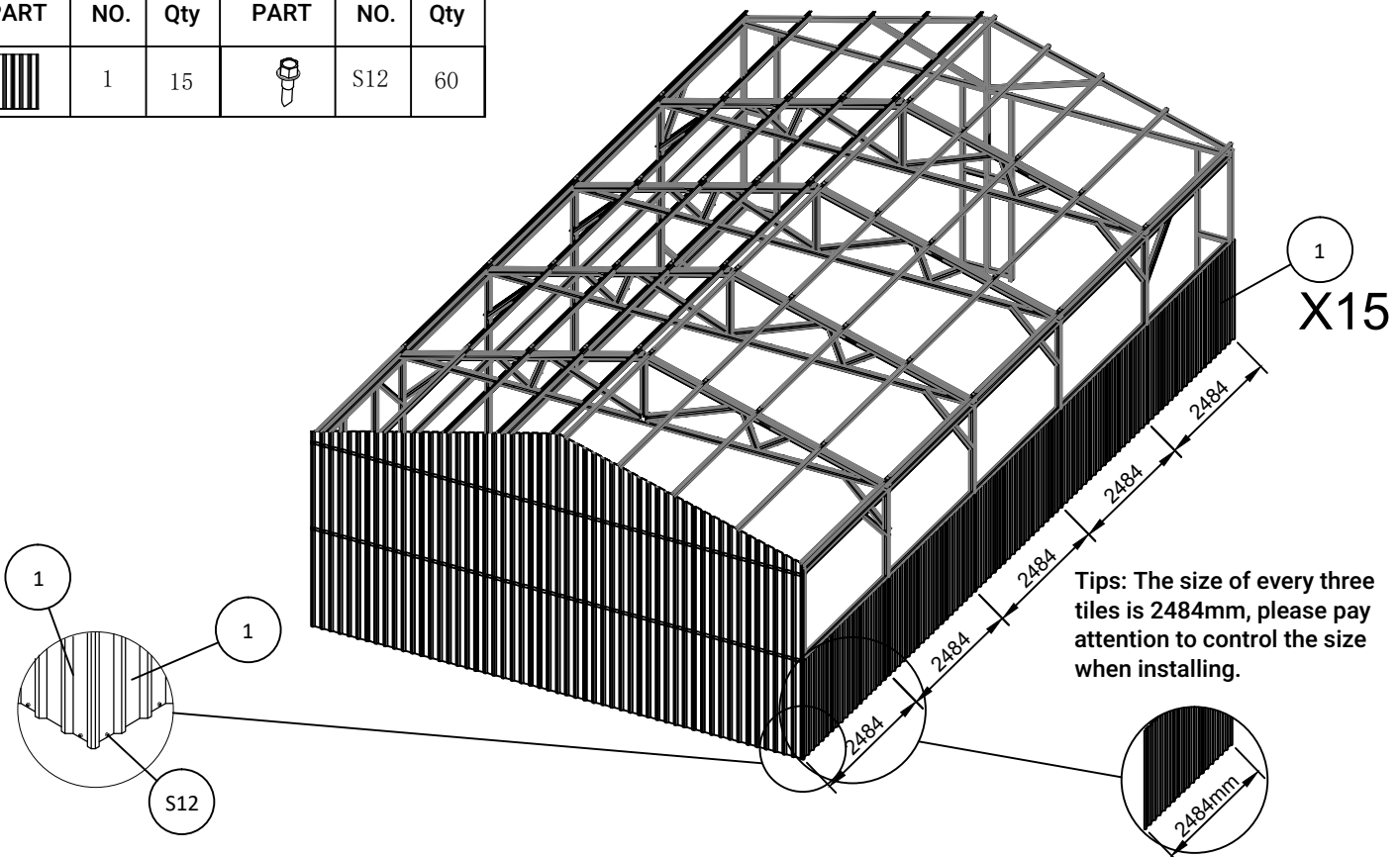

PART	NO.	Qty	PART	NO.	Qty
	1	15		S12	60





Tips: The size of every three tiles is 2484mm, please pay attention to control the size when installing.

INSTALLATION OF WALL TILE

PART	NO.	Qty	PART	NO.	Qty
	1	14		S12	112

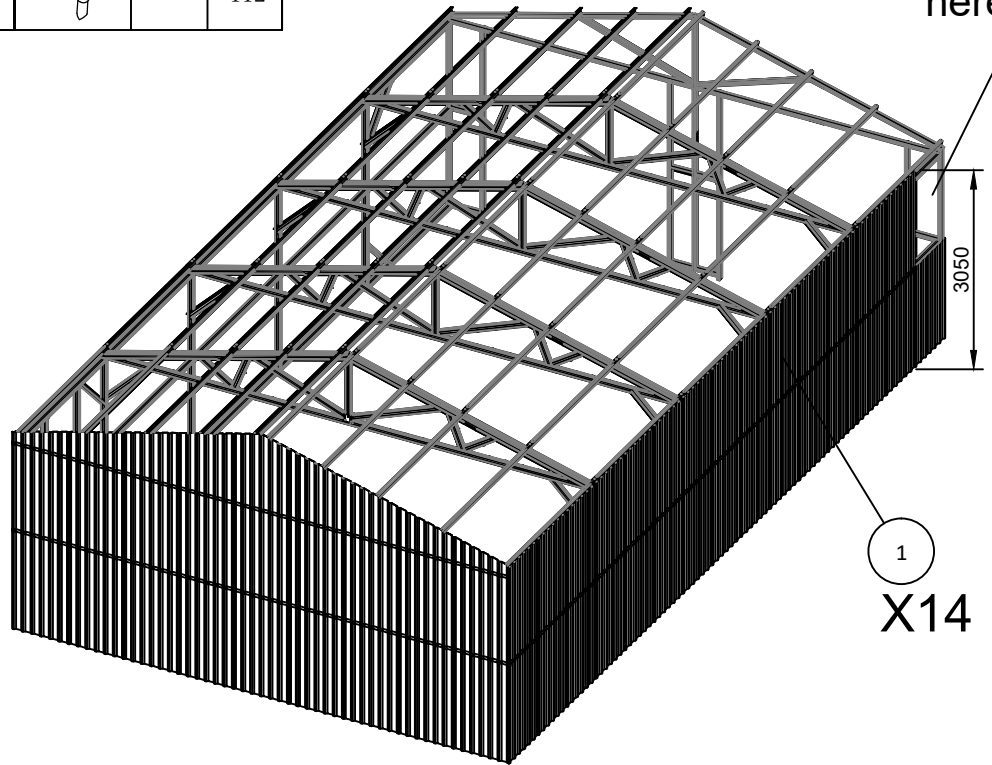

Install 2 here.



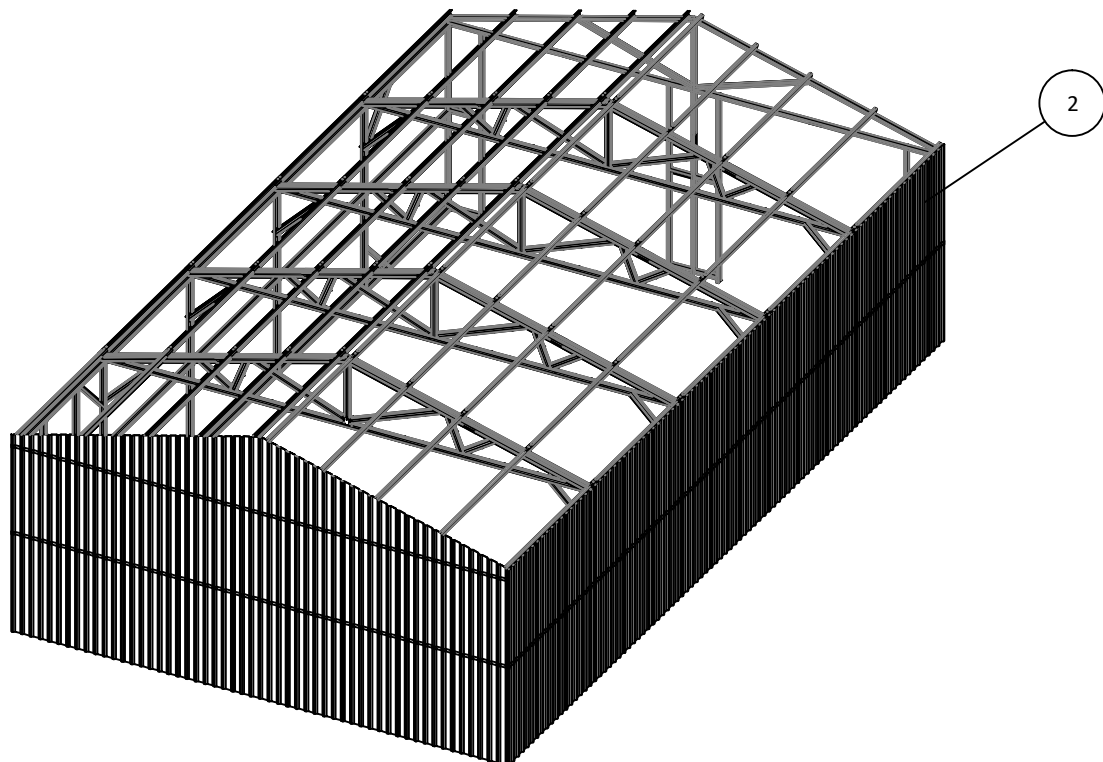



PART	NO.	Qty	PART	NO.	Qty
	2	1		S12	8

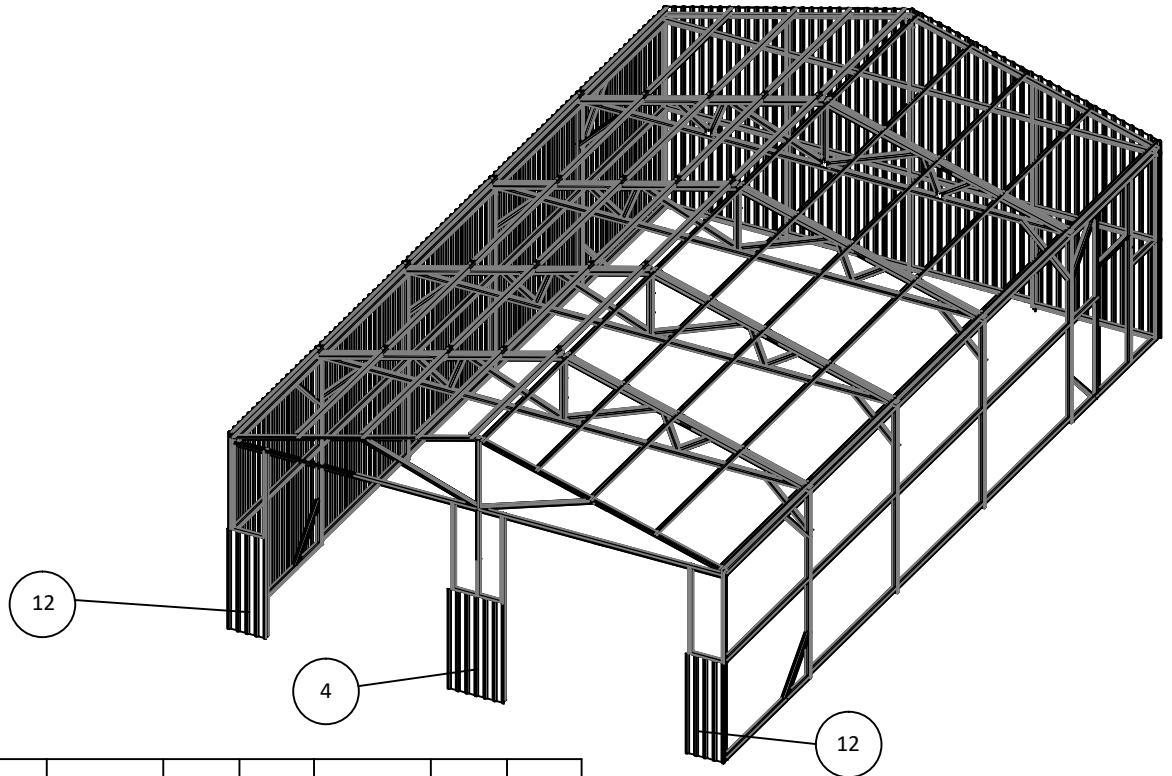

INSTALLATION OF WALL TILE







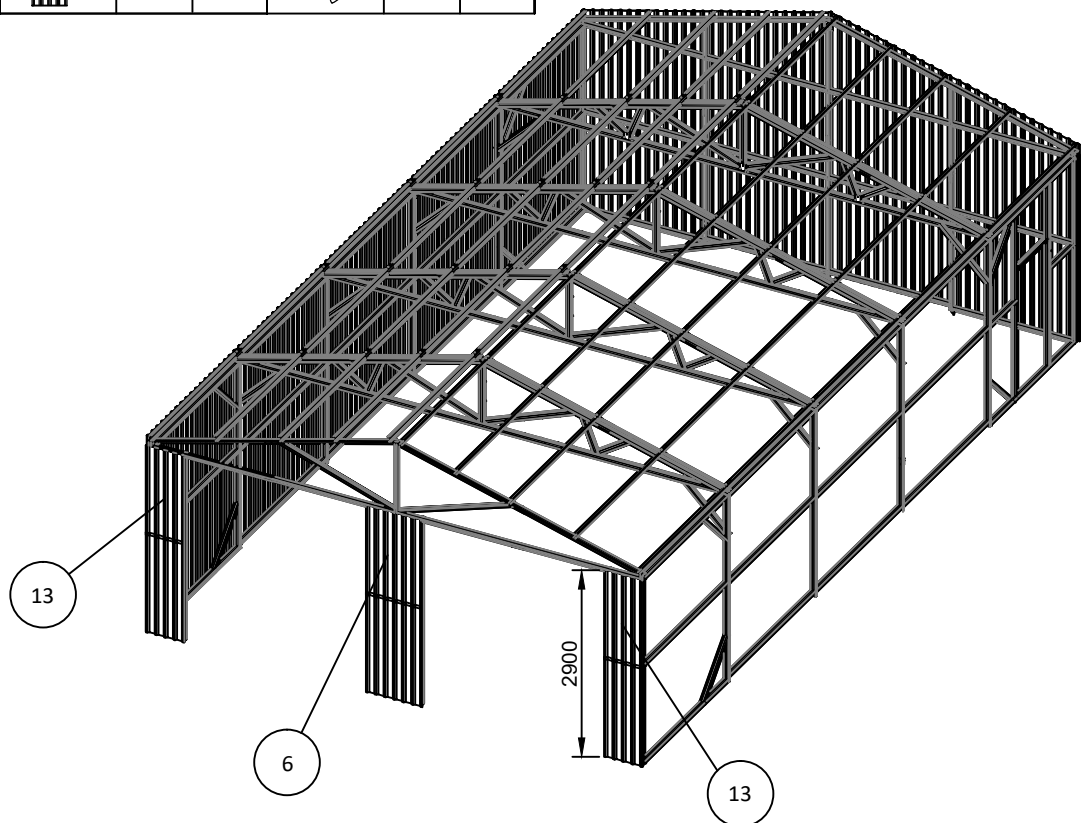



PART	NO.	Qty	PART	NO.	Qty	PART	NO.	Qty
	4	1		12	2		S12	12





PART	NO.	Qty	PART	NO.	Qty	PART	NO.	Qty
	6	1		13	2		S12	12



INSTALLATION OF WALL TILE

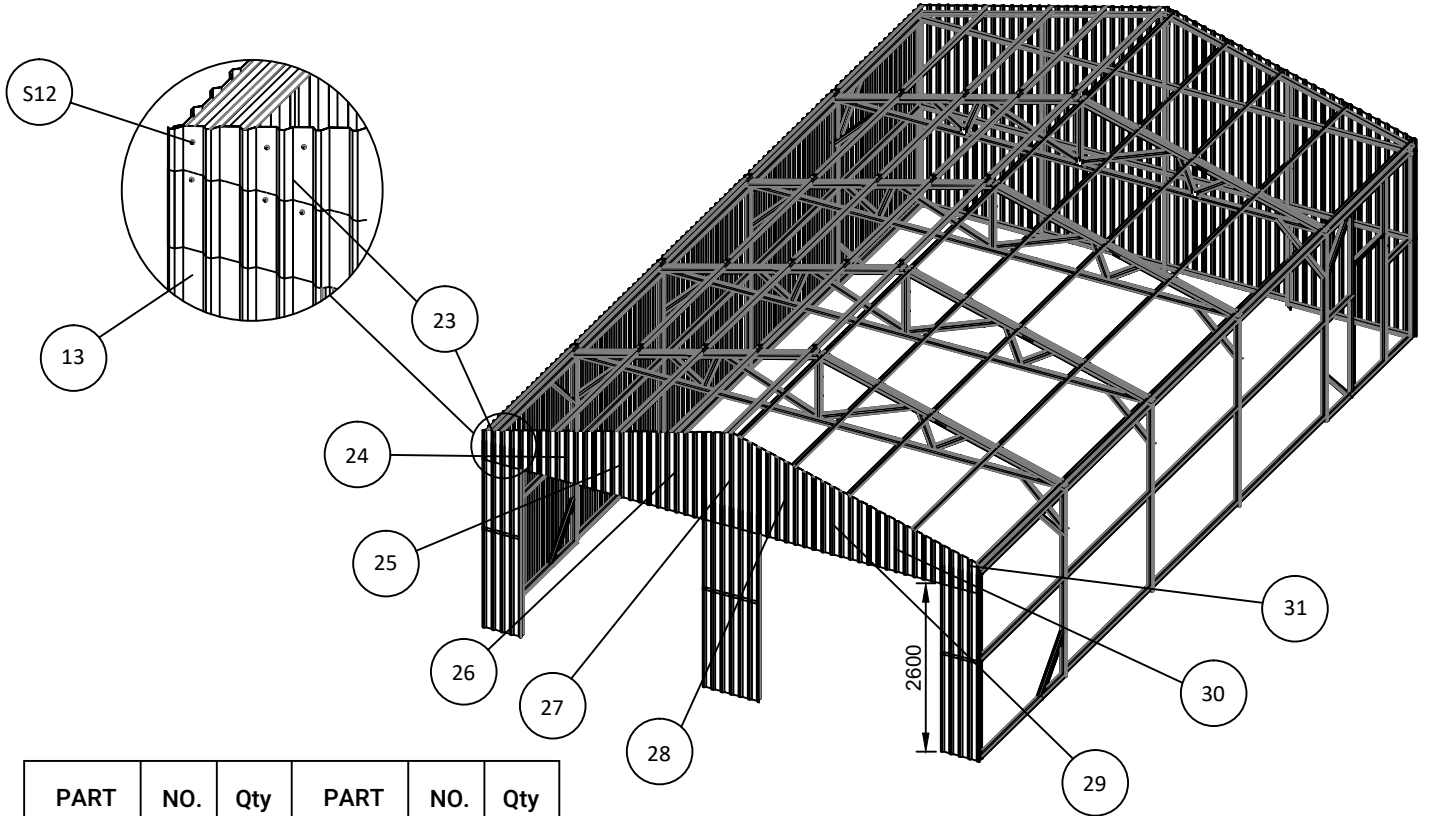



PART	NO.	Qty	PART	NO.	Qty	PART	NO.	Qty	PART	NO.	Qty	PART	NO.	Qty
	S12	72		23	1		24	1		25	1		26	1
	27	1		31	1		30	1		29	1		28	1

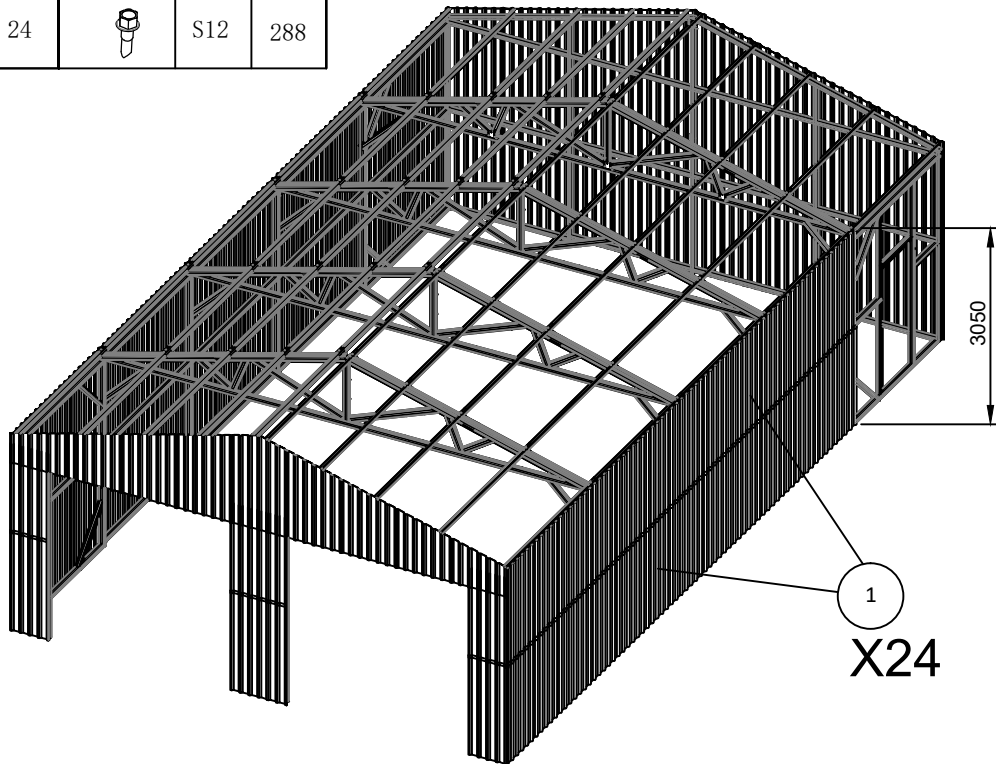





PART	NO.	Qty	PART	NO.	Qty
	1	24		S12	288

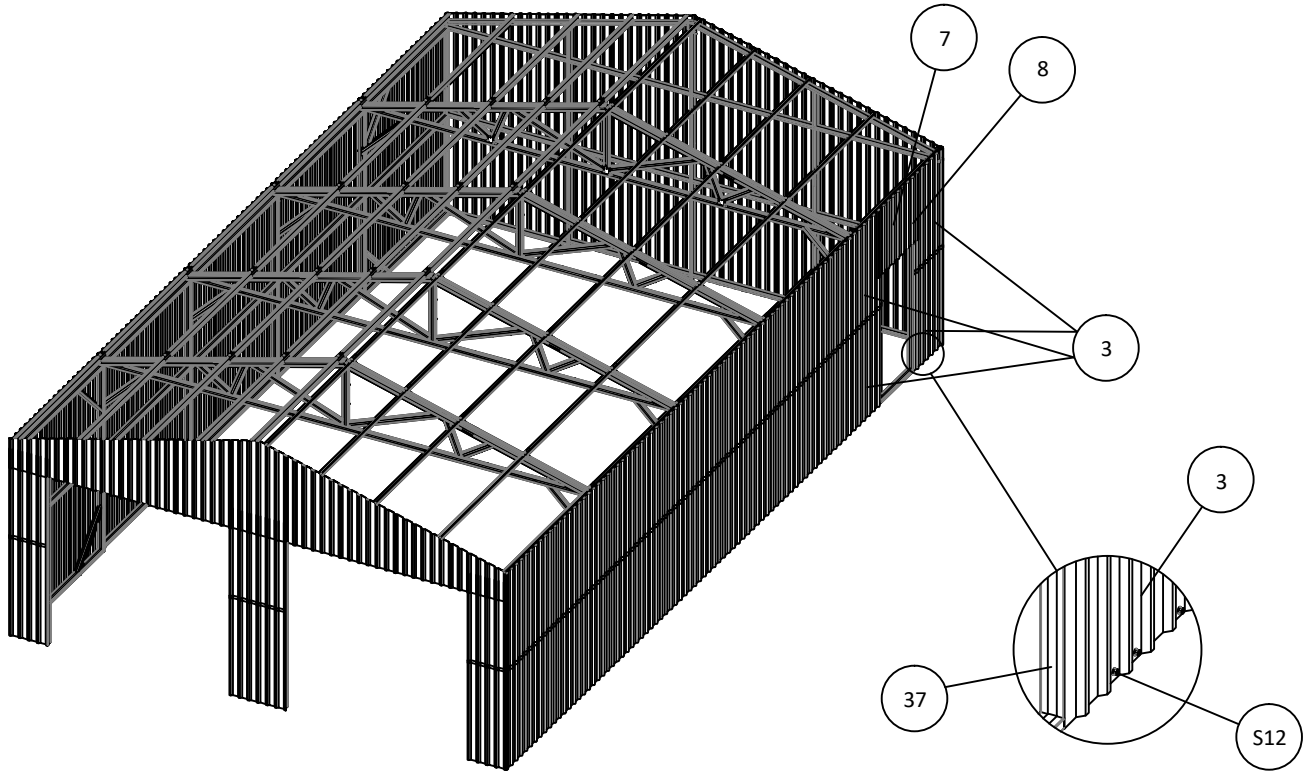

INSTALLATION OF WALL TILE



PART	NO.	Qty	PART	NO.	Qty	PART	NO.	Qty	PART	NO.	Qty
	3	4		7	1		8	1		S12	26

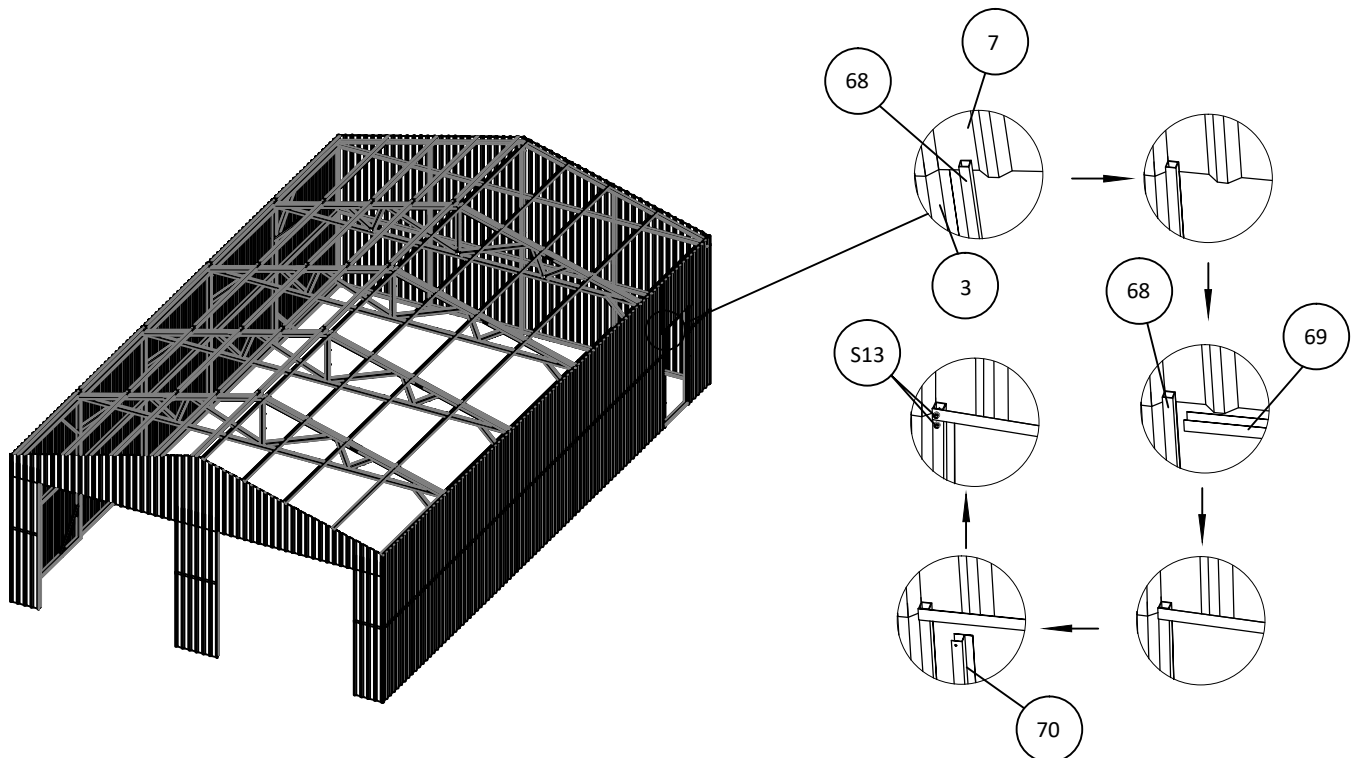

PART	NO.	Qty	PART	NO.	Qty	PART	NO.	Qty	PART	NO.	Qty
	69	1		70	2		68	2		S13	13





INSTALLATION OF WALL TILE

PART	NO.	Qty	PART	NO.	Qty
	10	1		S12	20

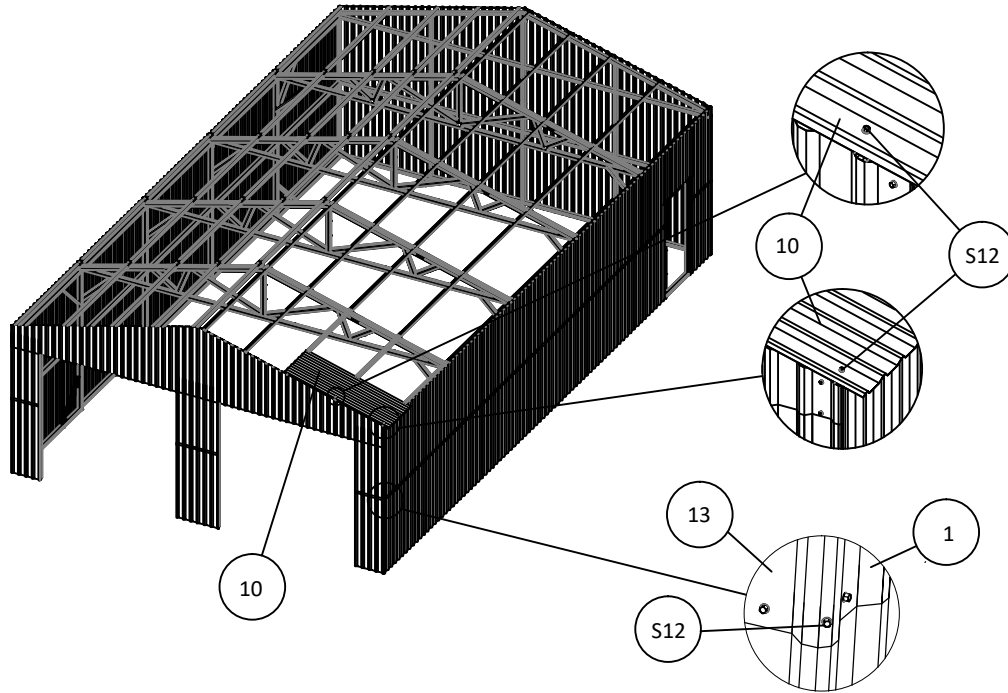
TIPS: To install transparent panels, please refer to page 52.



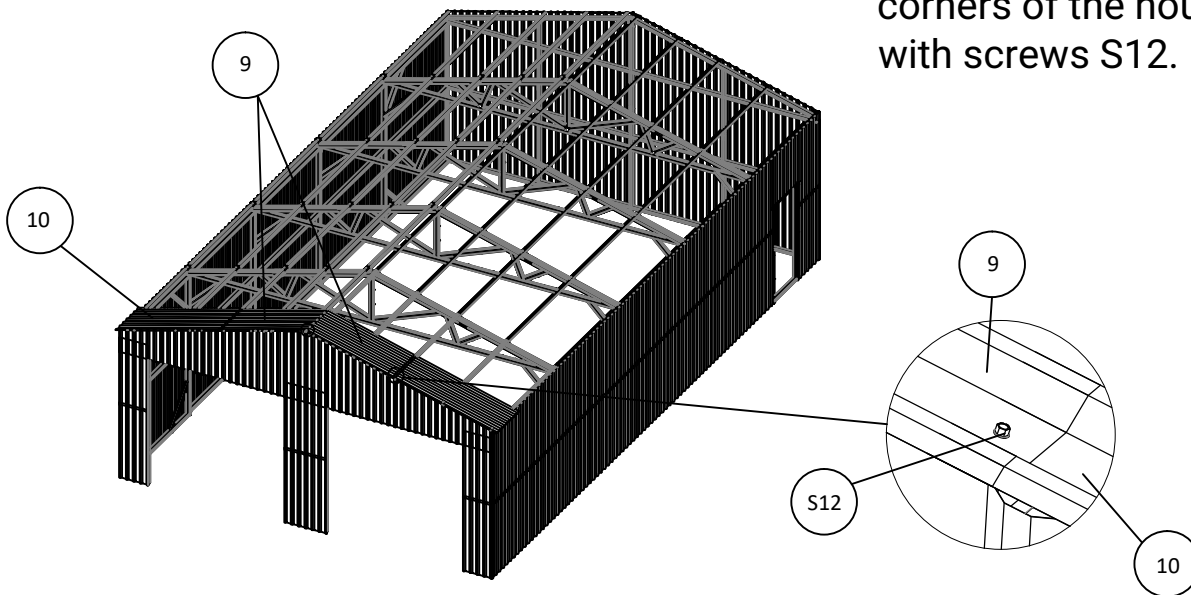

PART	NO.	Qty	PART	NO.	Qty	PART	NO.	Qty
	9	2		10	1		S12	32

As shown in the figure, the four corners of the house are fixed with screws S12.





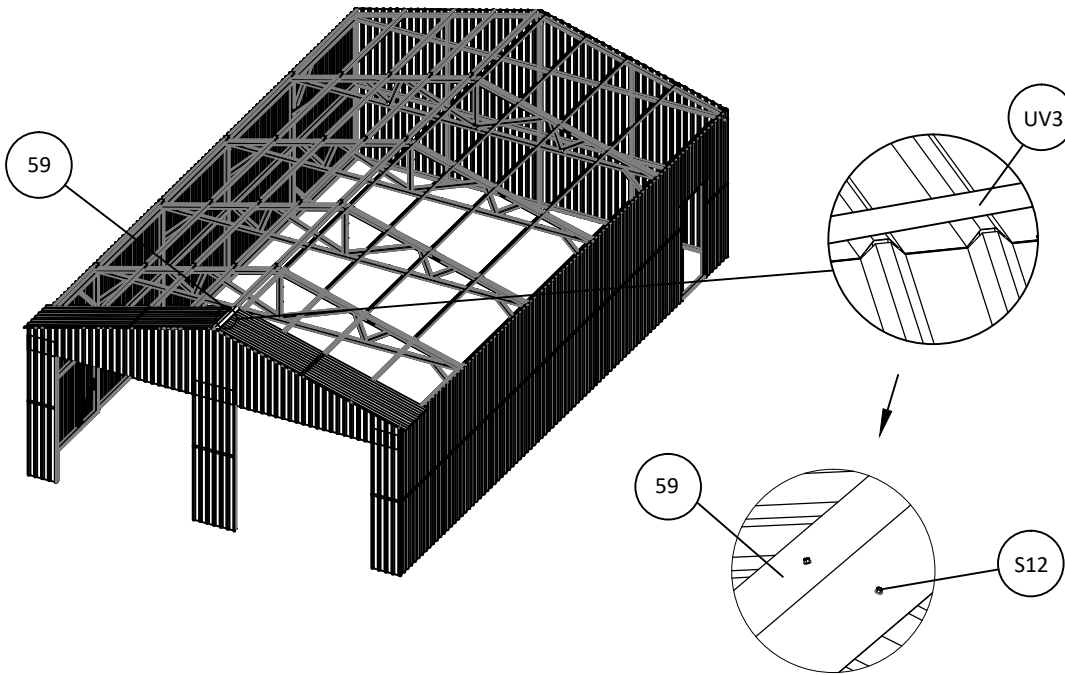

INSTALLATION OF WALL TILE

PART	NO.	Qty	PART	NO.	Qty	PART	NO.	Qty
	59	1		S12	2		UV3	1



As shown in the figure, first stick a layer of waterproof tape at the joint of the two panels, and then install the ridge.



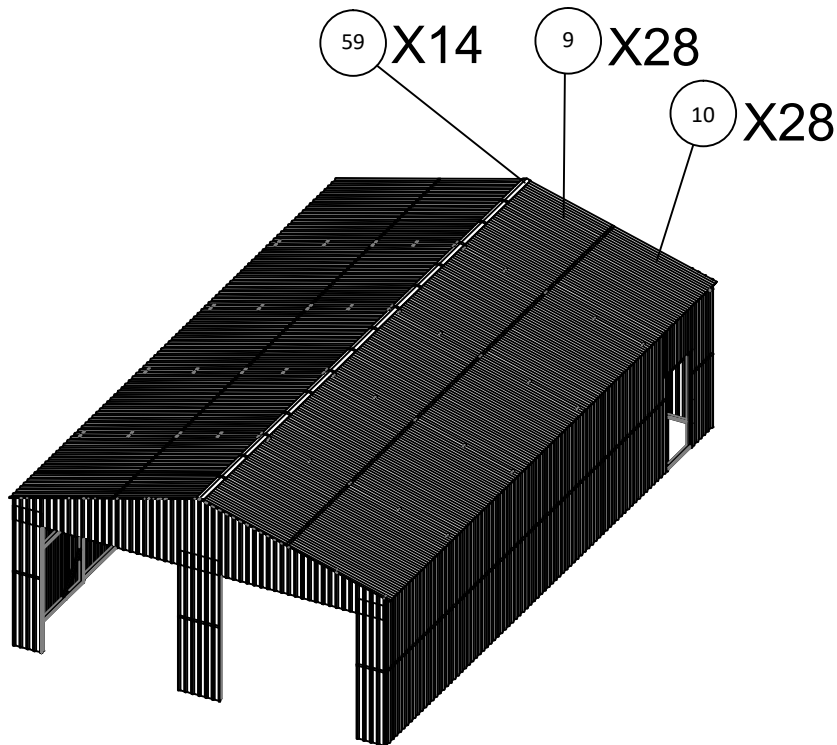

PART	NO.	Qty	PART	NO.	Qty	PART	NO.	Qty	PART	NO.	Qty
	9	28		10	28		S12	588		59	14



INSTALLATION OF WALL TILE

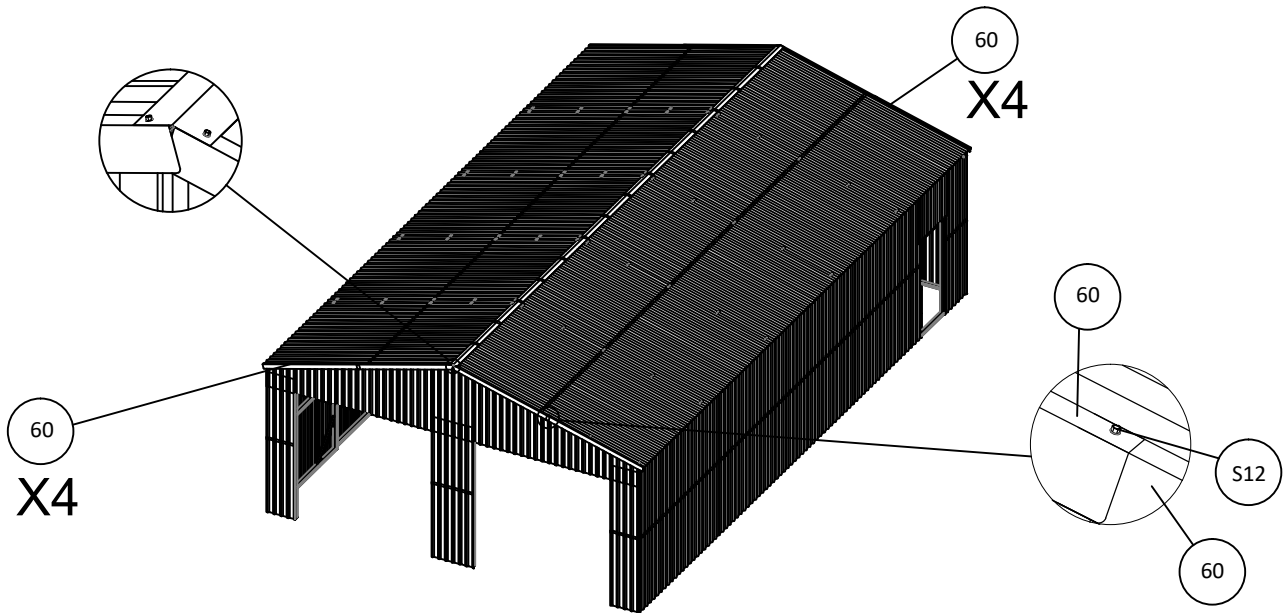

PART	NO.	Qty	PART	NO.	Qty
	60	8		S12	20



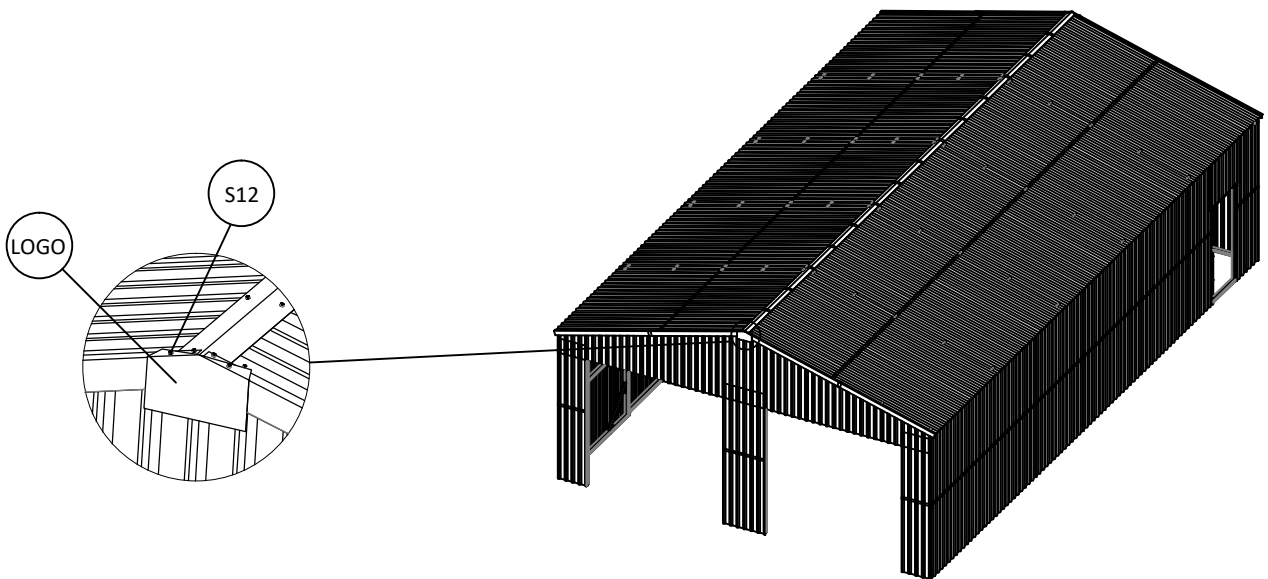



PART	NO.	Qty	PART	NO.	Qty
	LOGO	2		S12	4

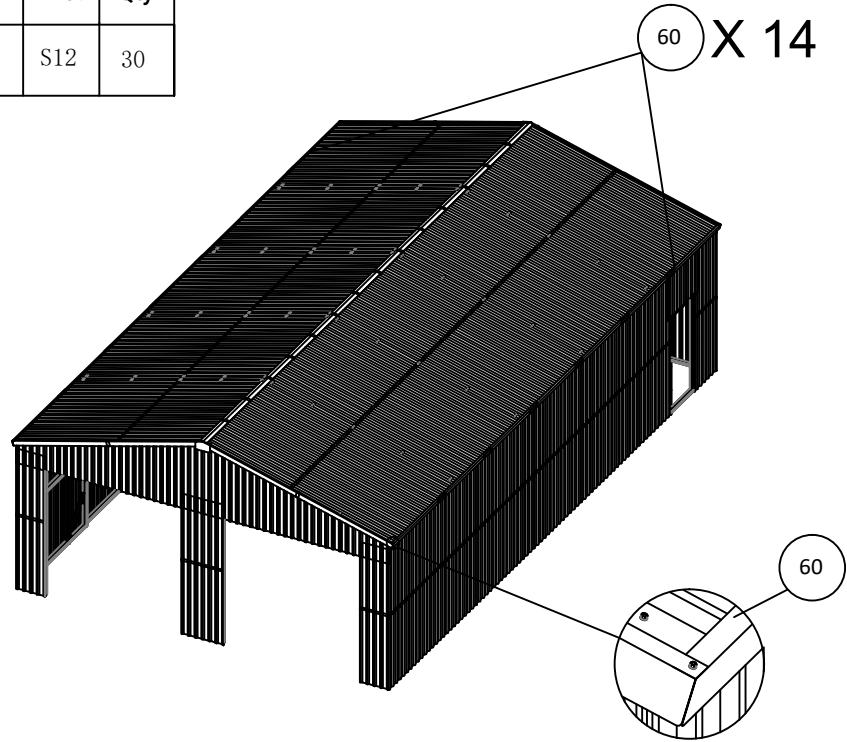

INSTALLATION OF WALL TILE

PART	NO.	Qty	PART	NO.	Qty
	60	14		S12	30



PART	NO.	Qty	PART	NO.	Qty	PART	NO.	Qty
	66	4		67	2		S12	24

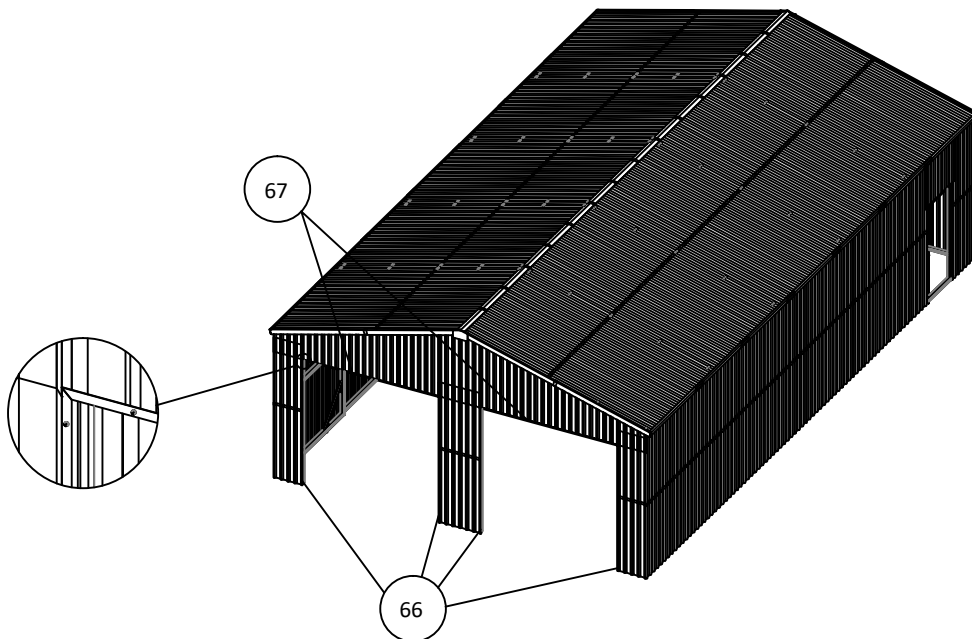





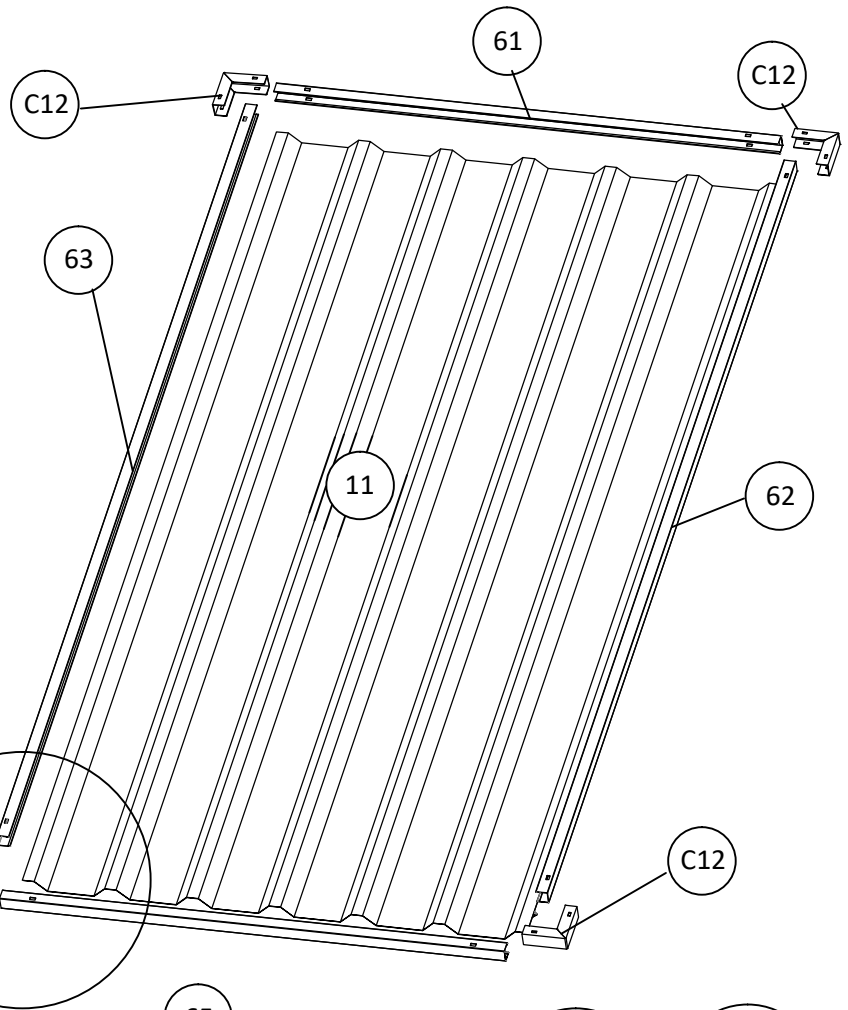



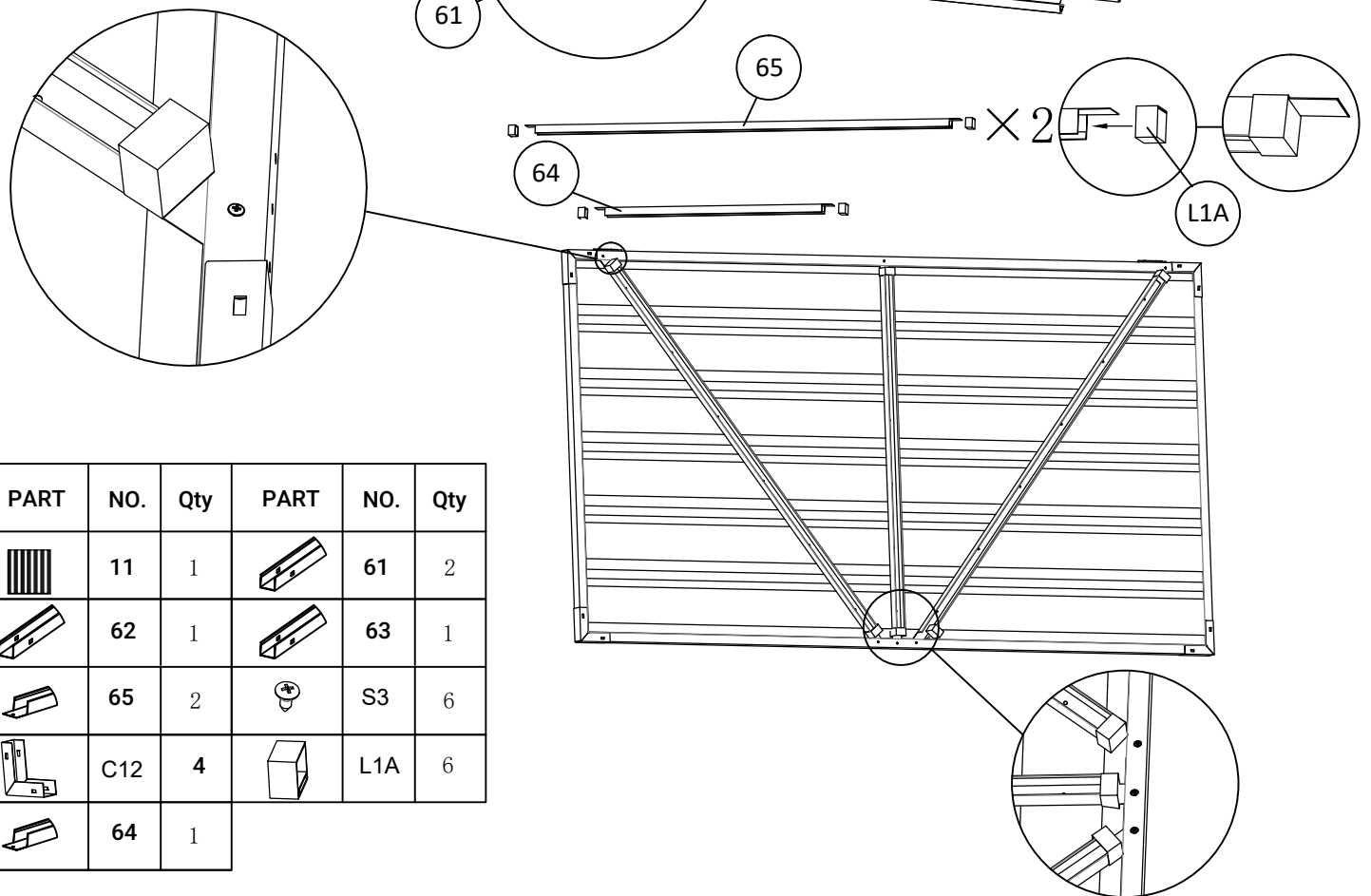

INSTALLATION OF SIDE DOOR

STEP 1.







STEP 2.



PART	NO.	Qty	PART	NO.	Qty
	11	1		61	2
	62	1		63	1
	65	2		S3	6
	C12	4		L1A	6
	64	1			

INSTALLATION OF SIDE DOOR

STEP 3.

PART	NO.	Qty	PART	NO.	Qty
	SH1	2		S3	18
	S7	6		L3	18
	S5	18	Cap all S3 tips with L3.		

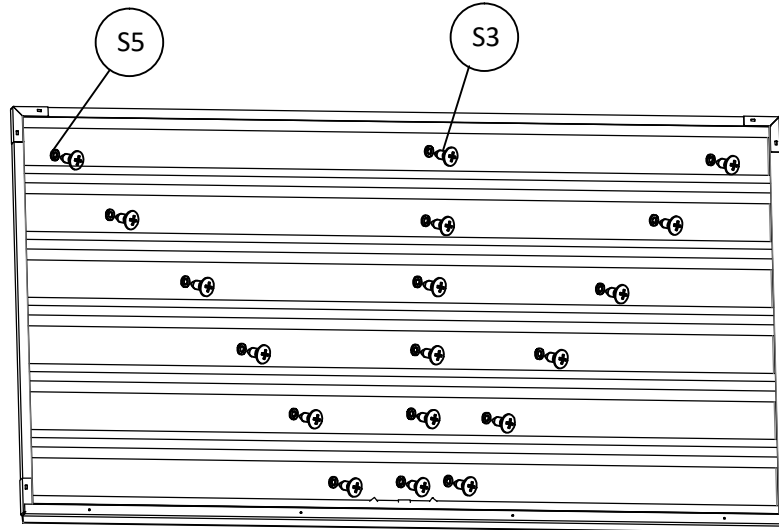

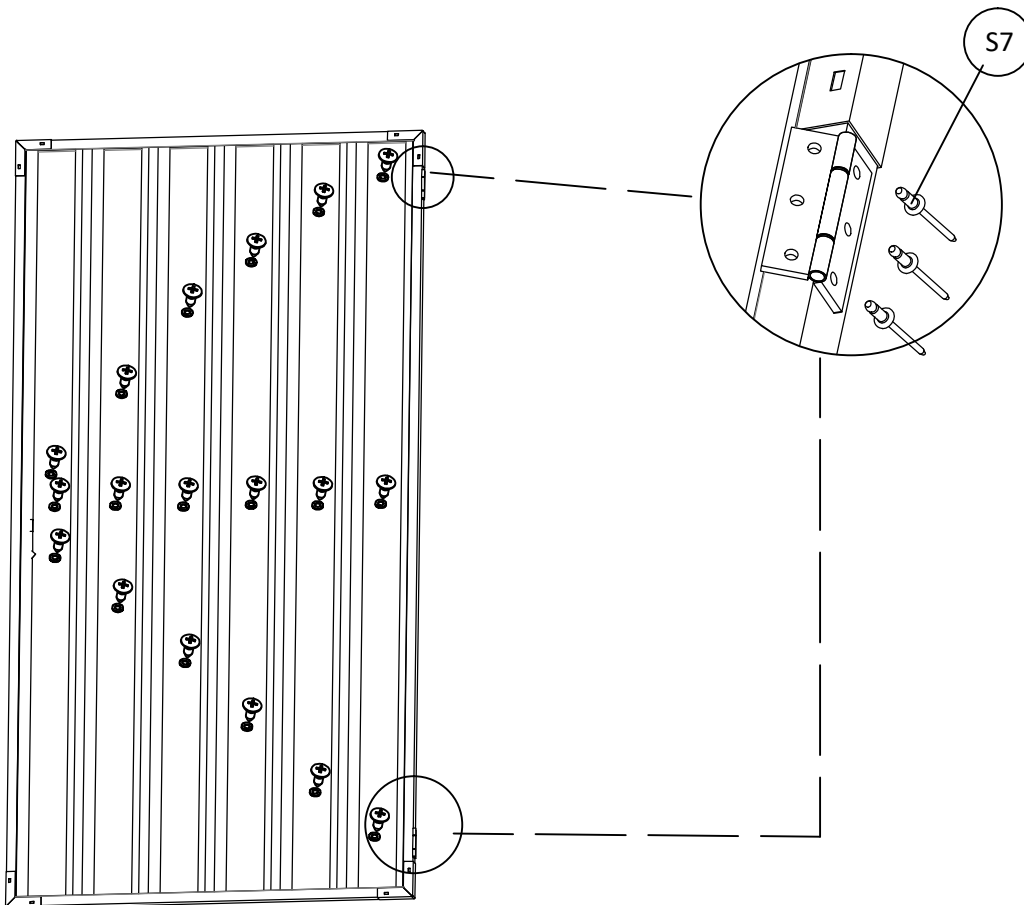

STEP 4.

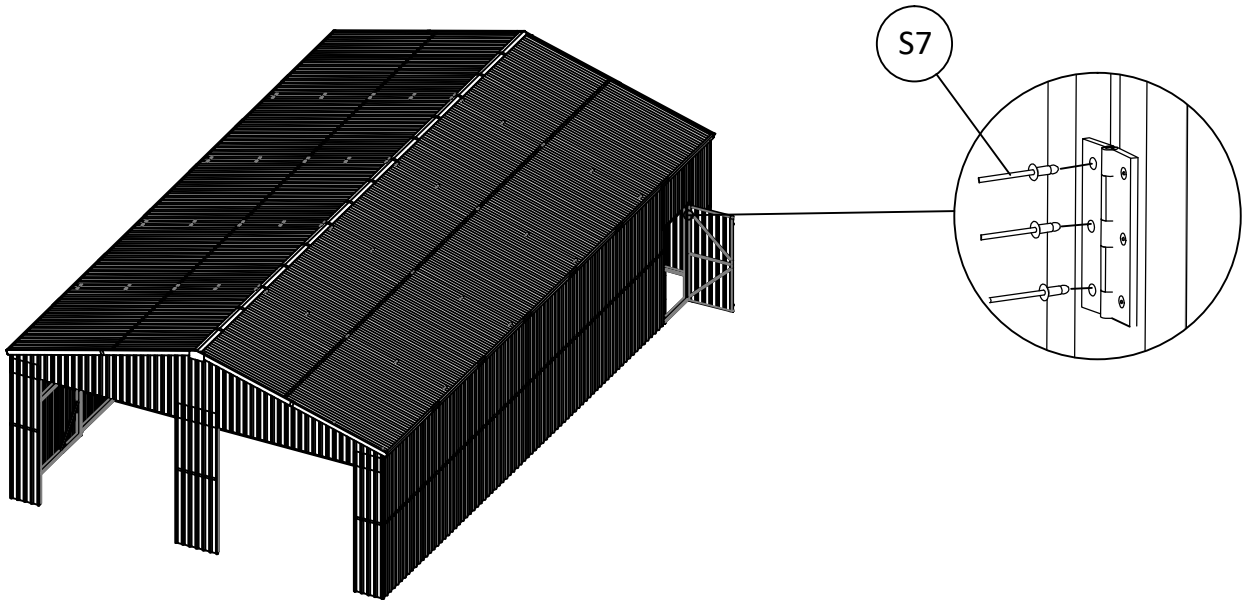

INSTALLATION OF SIDE DOOR

PART	NO.	Qty
	S7	6

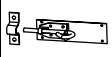

PART	NO.	Qty
	H13	1
	S7	6

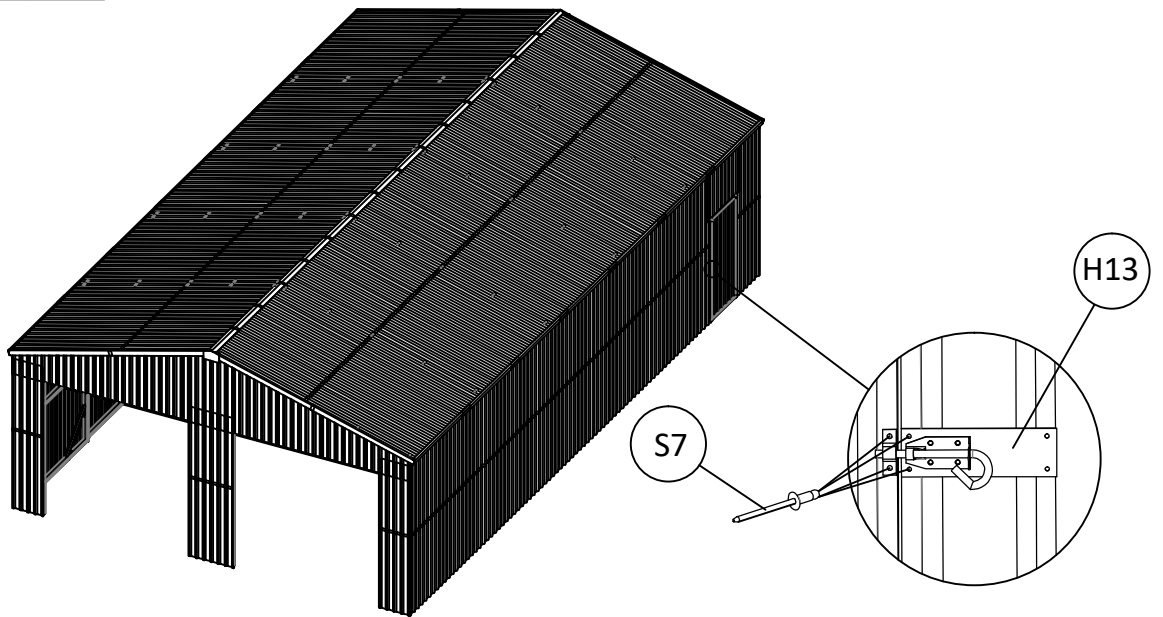

ASSEMBLY OF THE DOOR MAY REQUIRE THE FOLLOWING PARTS

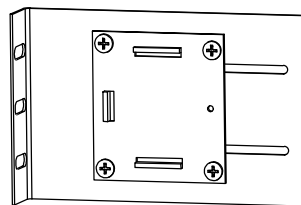
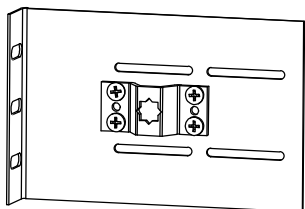

A

B

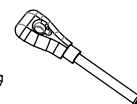
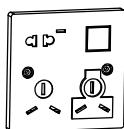
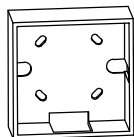
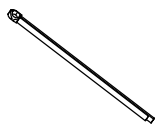

C

D

E

F

H

I

J

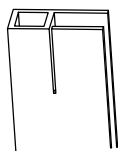

K

L

GR1

GR2

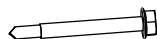

S12

S13

ASSEMBLY OF ROLLER DOOR

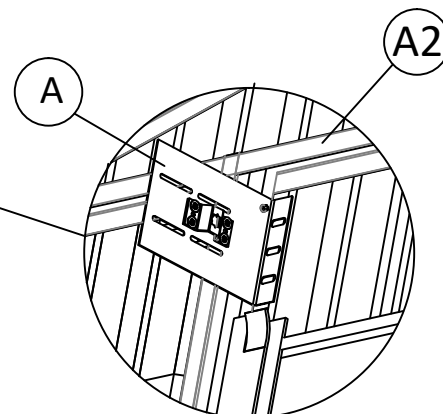
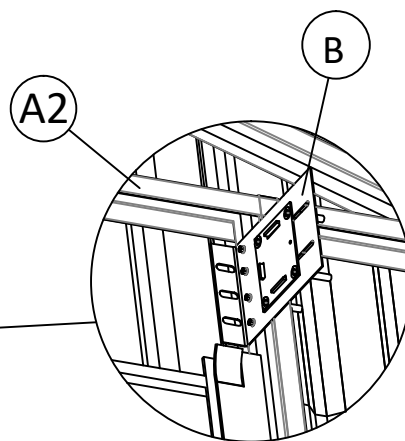
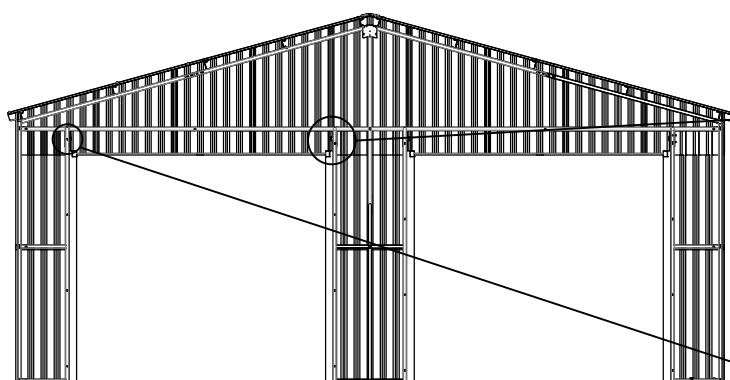
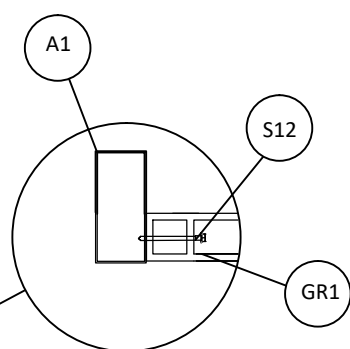
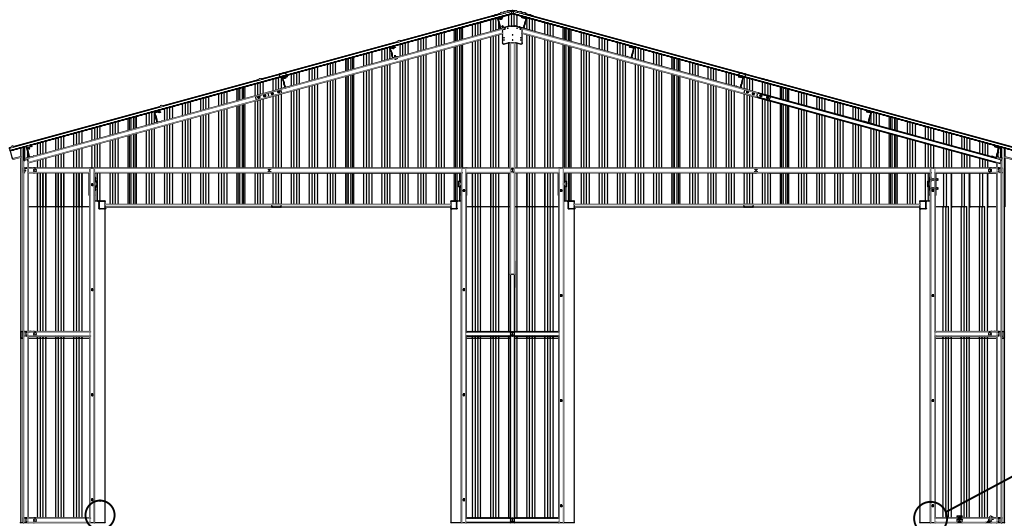
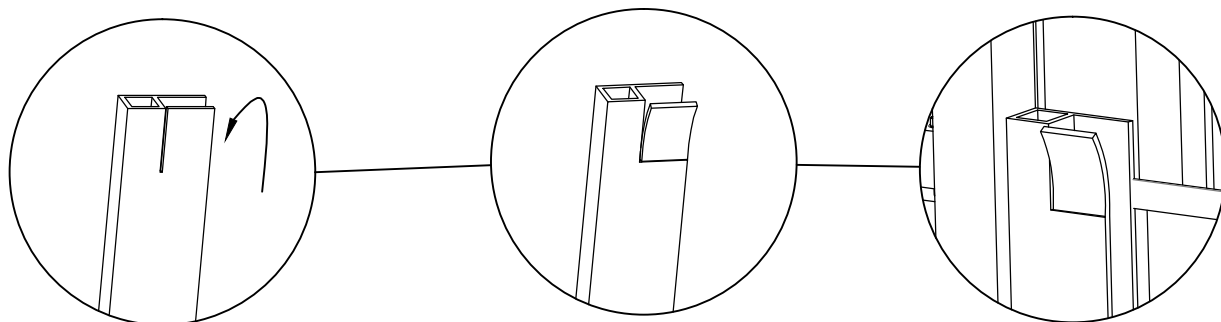

ASSEMBLY OF ROLLER DOOR

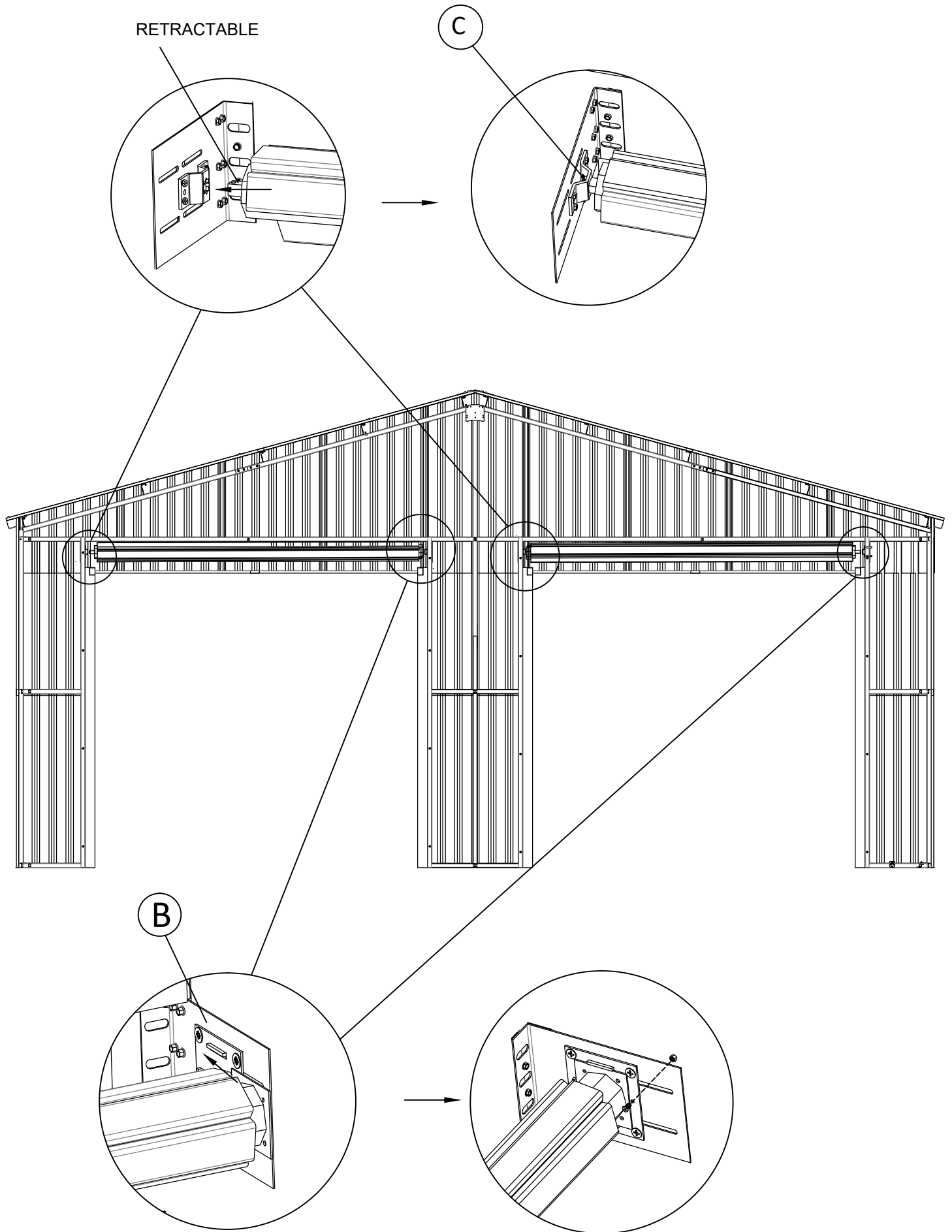

ASSEMBLY OF ROLLER DOOR

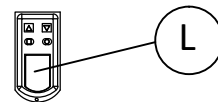
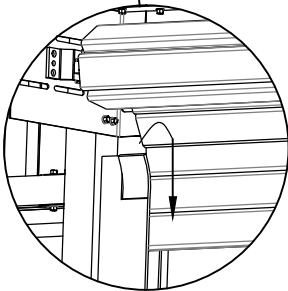
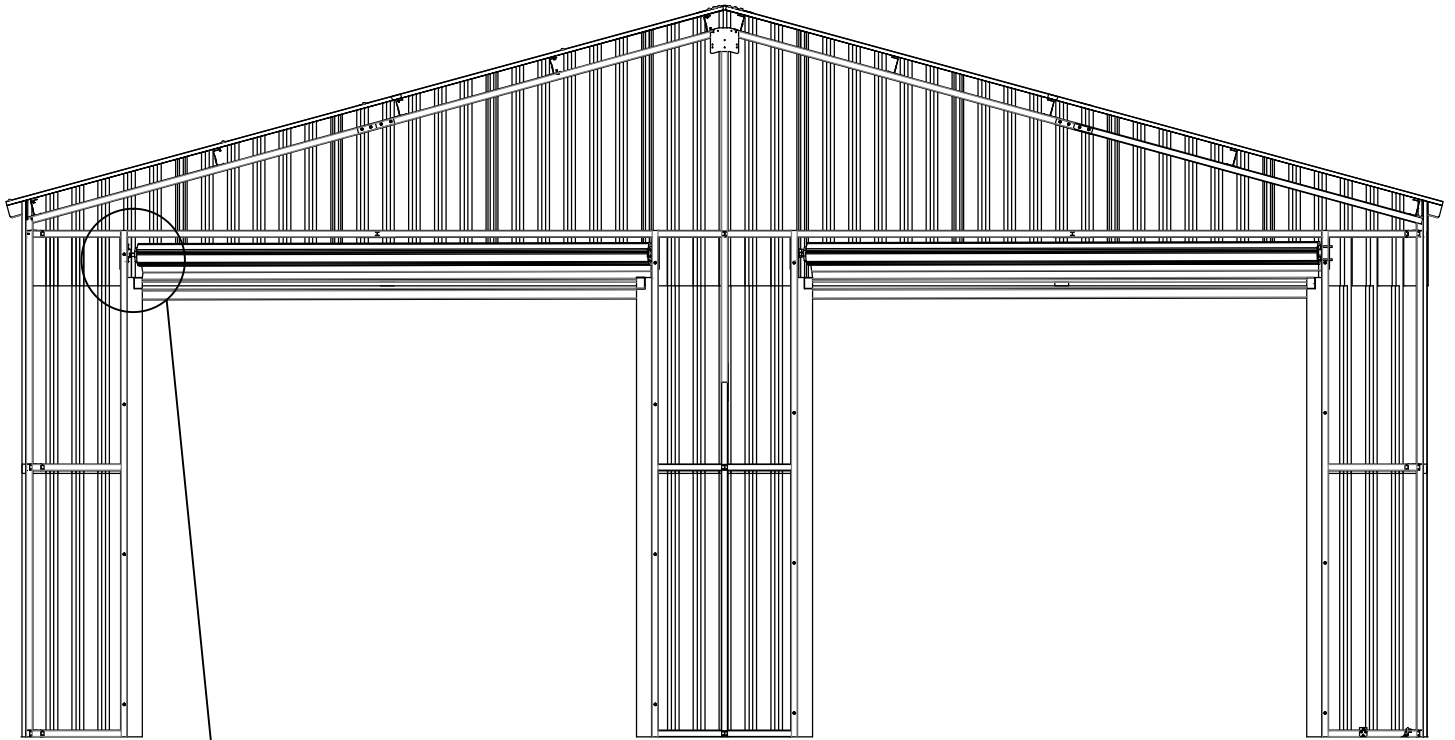
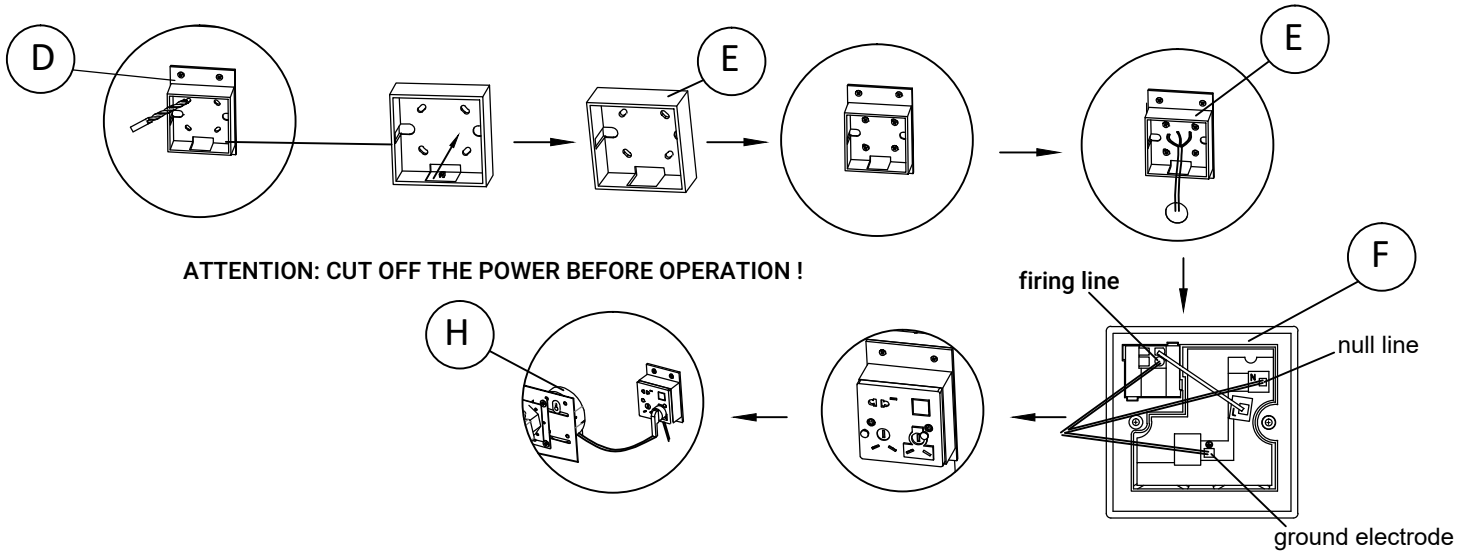

POWER-ON, THEN CONTROL THE REMOTE CONTROL, SLOWLY INSERT THE ROLLER DOOR INTO GR1 AND GR2.

ASSEMBLY OF ROLLER DOOR

1. ADJUST THE LOWER LIMIT

Assume that C is the direction in which the roller door goes down. Press the downward button on the remote control, the roller door goes down. If the electrical machine stops rotating when it reaches the position in picture D, adjust A to rotate in the direction of "+" until the roller door is parallel to the ground. If the electrical machine is still rotating downward when the roller door touches the ground, press the stop button, adjust A to rotate in the direction of "-".

2. ADJUST THE UPPER LIMIT

Press the upward button on the remote control, The roller door goes up. If the electrical machine stops rotating when it reaches the position in picture E, adjust B to rotate in the direction of "+", and pay attention not to slipping off the guide rail until it gets an appropriate position. If the roller door is still operating upward when it gets the appropriate position, press the stop button, adjust A to rotate in the direction of "-".

3. ADJUST THE UPPER AND LOWER LIMIT REPEATEDLY UNTIL IT OPERATES SMOOTHLY.

4. ROTATE THE ROLLER DOOR WITH THE ROCKER (IN PICTURE J) WHEN POWER CUT.

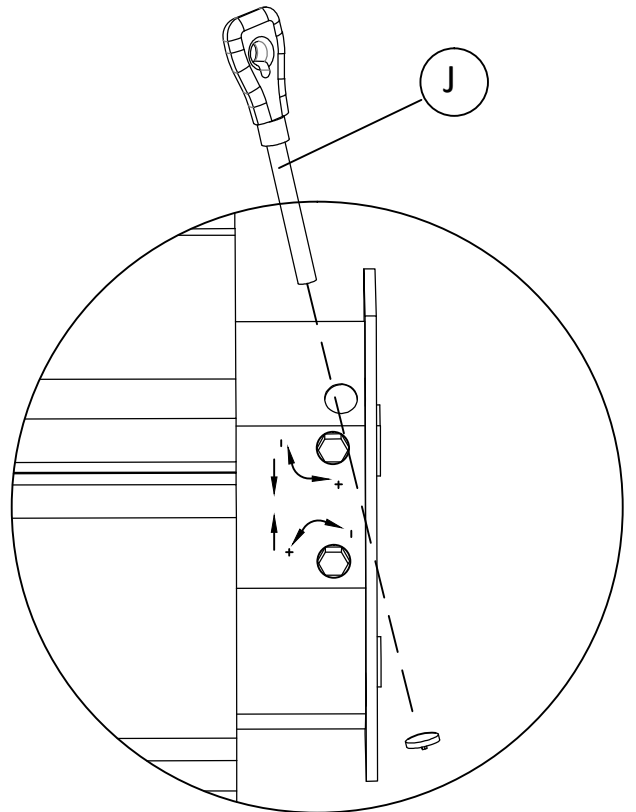
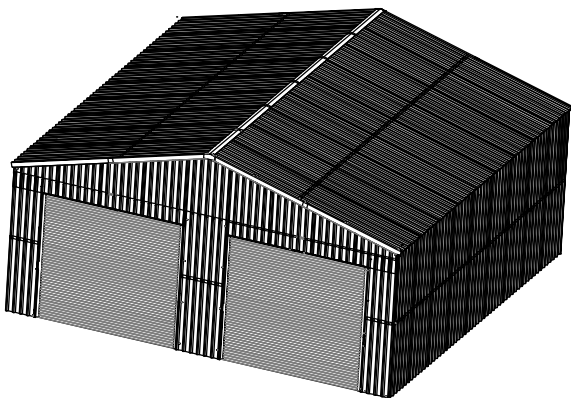
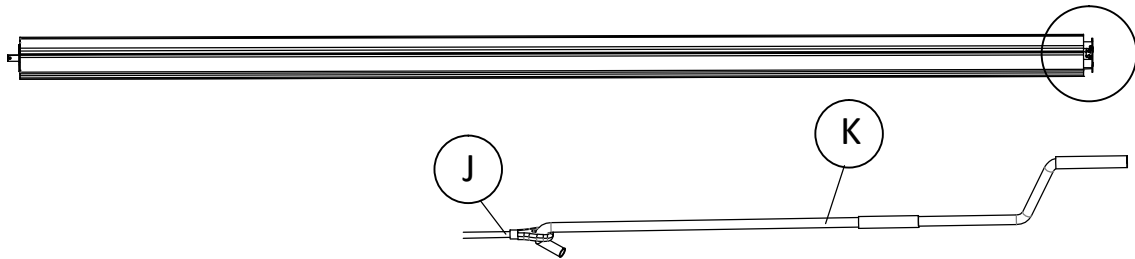
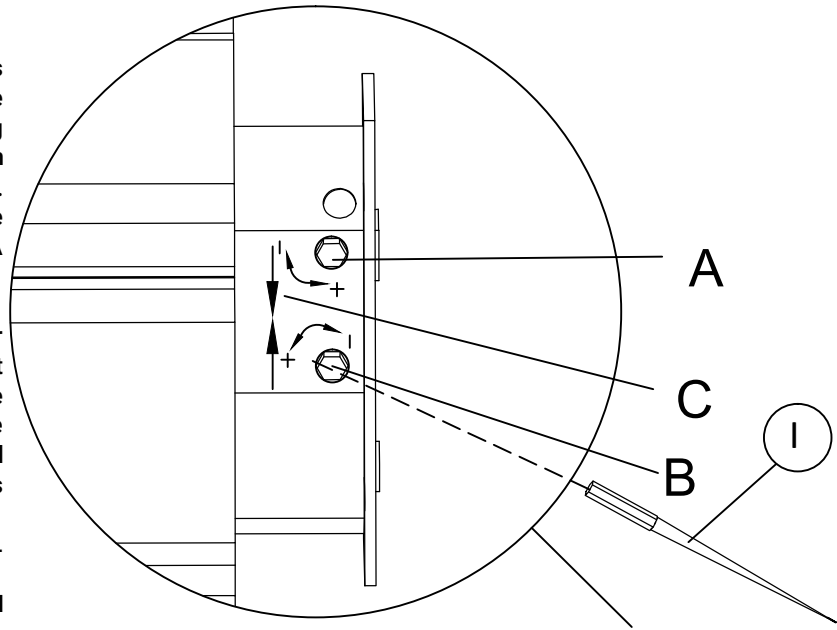

INSTALLATION OF FRAMEWORK

PART	NO.	Qty	PART	NO.	Qty	PART	NO.	Qty	PART	NO.	Qty	PART	NO.	Qty
	39	3		38	4		35	2		36	1		37	2
	50	3		42	1		41	1		43	1		57	3
	S11	2		C72	2		S12	152						

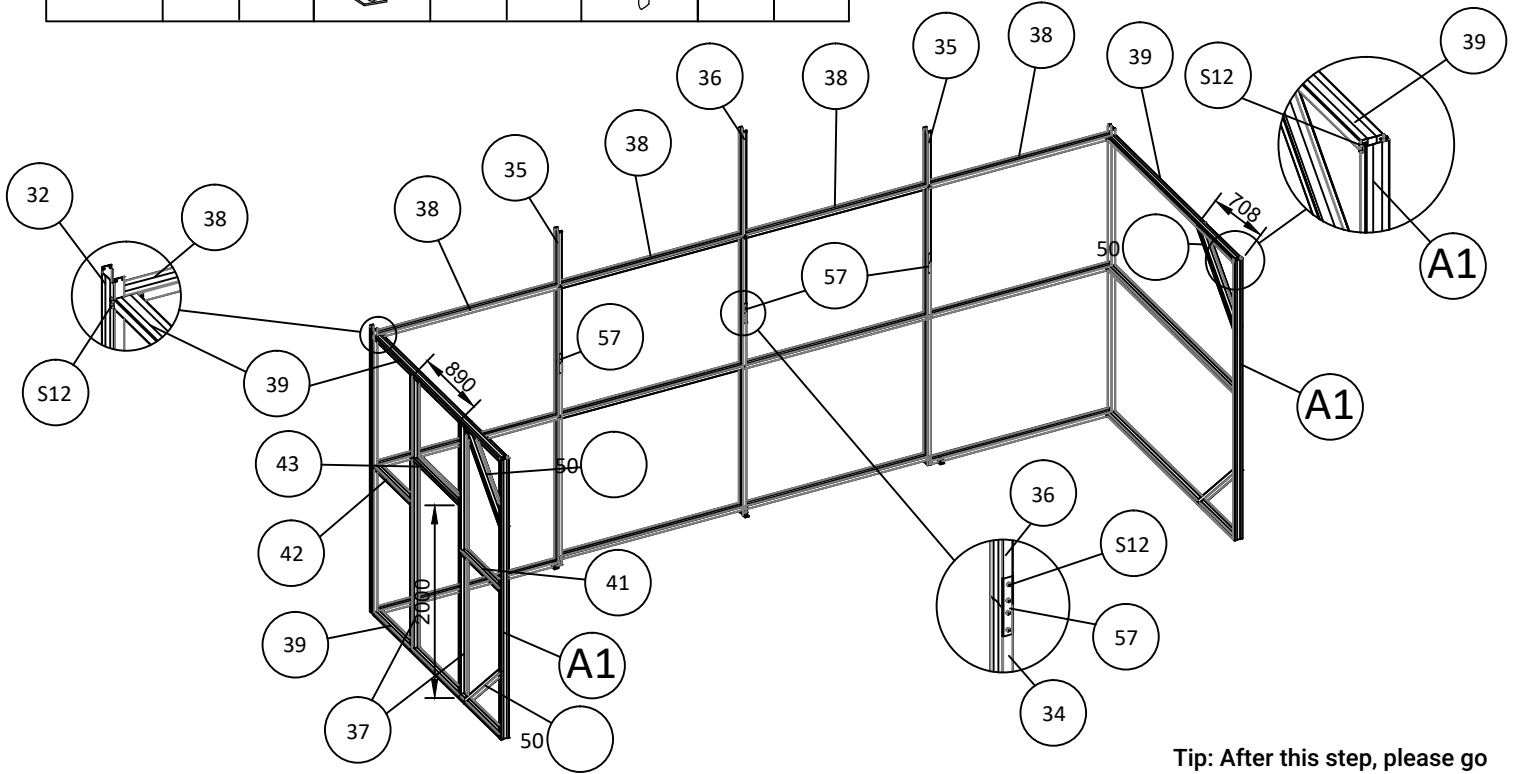



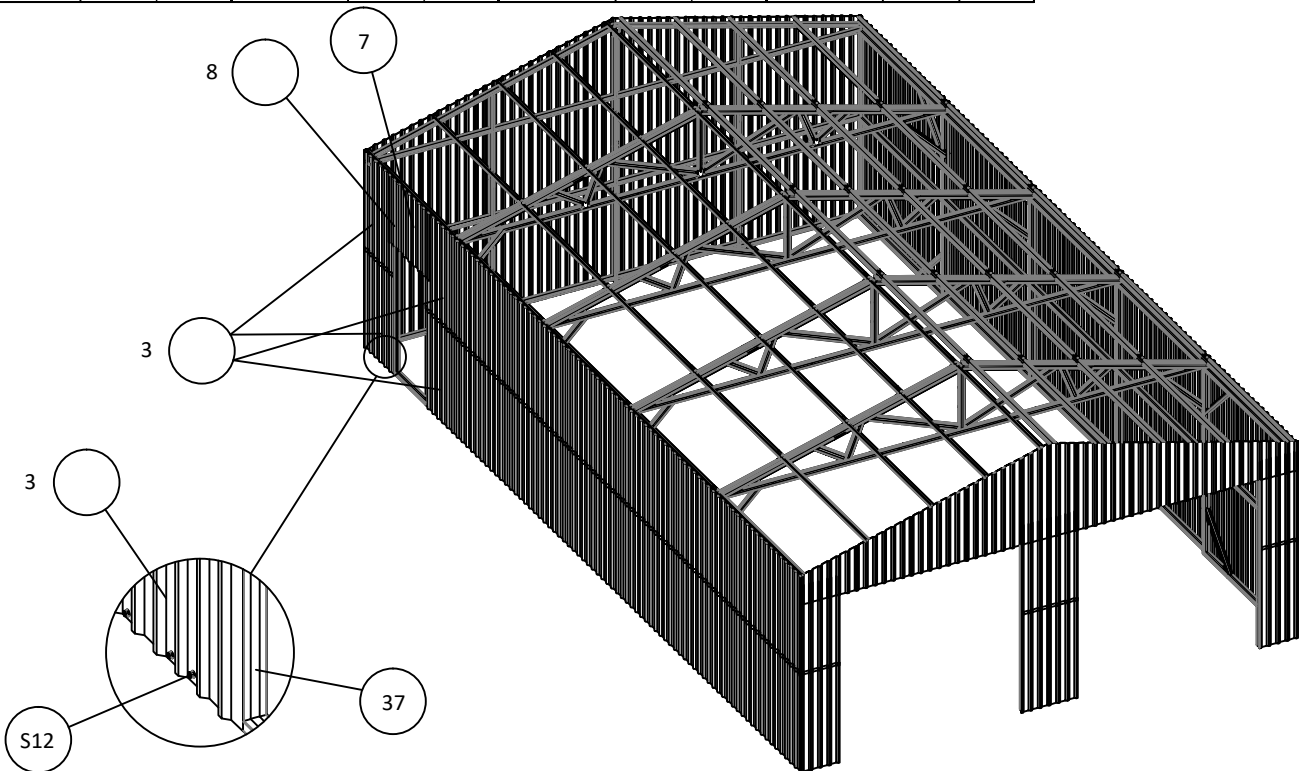

Tip: After this step, please go back to page 23 to continue the installation.

PART	NO.	Qty	PART	NO.	Qty	PART	NO.	Qty	PART	NO.	Qty
	3	4		7	1		8	1		S12	26



INSTALLATION OF FRAMEWORK

PART	NO.	Qty	PART	NO.	Qty	PART	NO.	Qty	PART	NO.	Qty
	69	1		70	2		68	2		S13	13

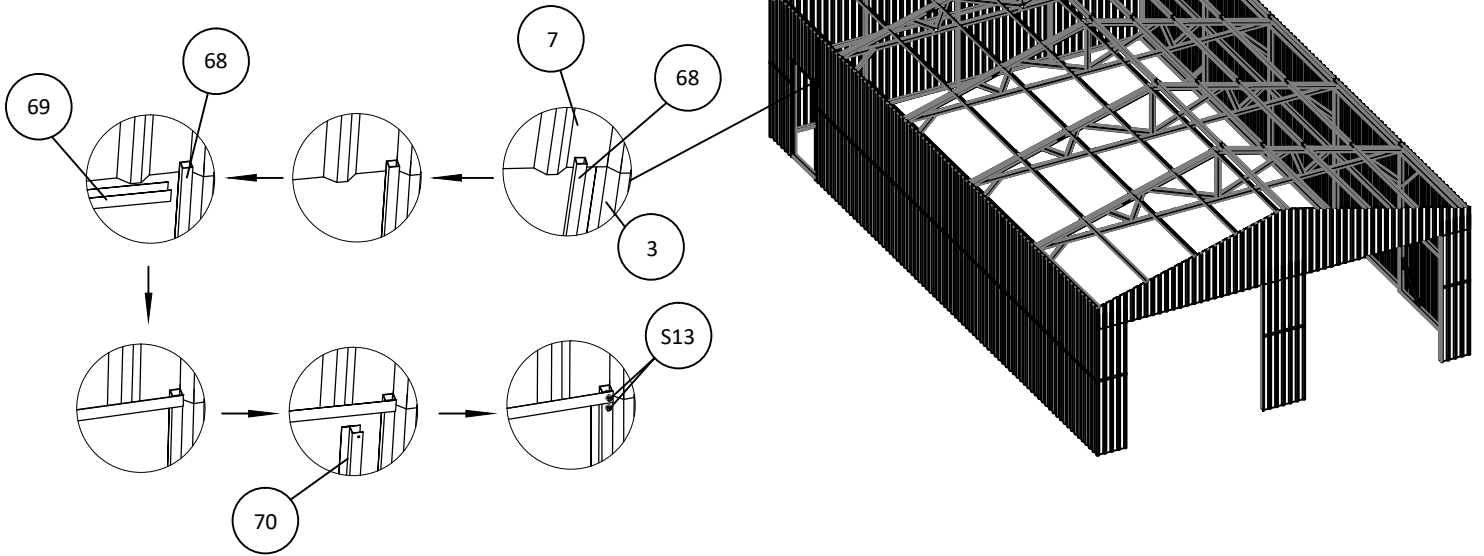

Correct Demonstration

transparent panel
with 1830mm length

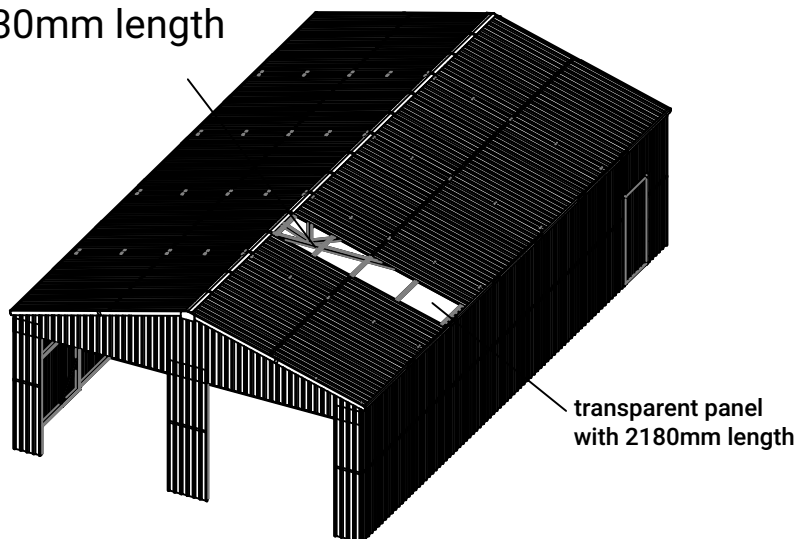

The blank space is where the transparent panels are installed. Please install them according to the correct position. The two transparent panels are stacked together. Incorrect installation will cause water leakage. Please pay special attention.

Error Demonstration

transparent panel
with 1830mm length

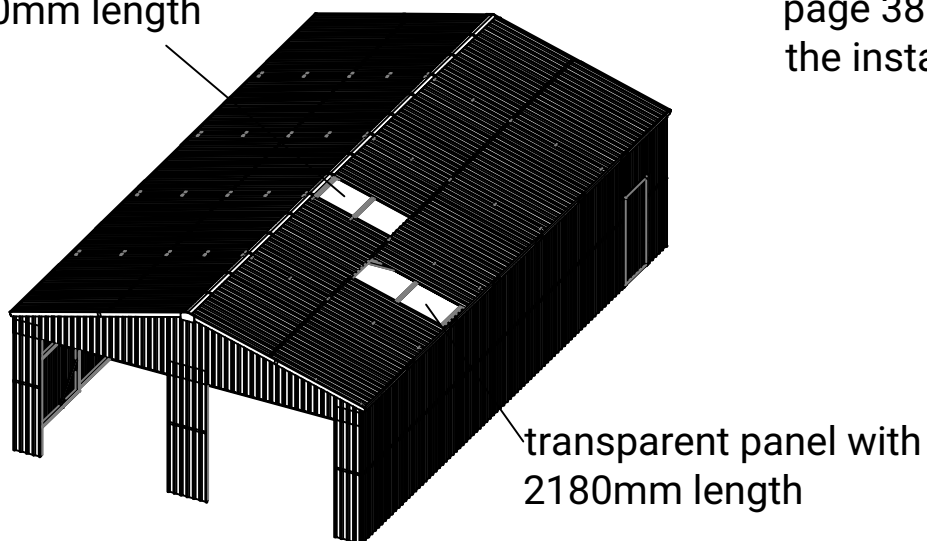

Tip: After this step,
please go back to
page 38 to continue
the installation.