

INSTALLATION INSTRUCTIONS

-----G1108-H180-2H

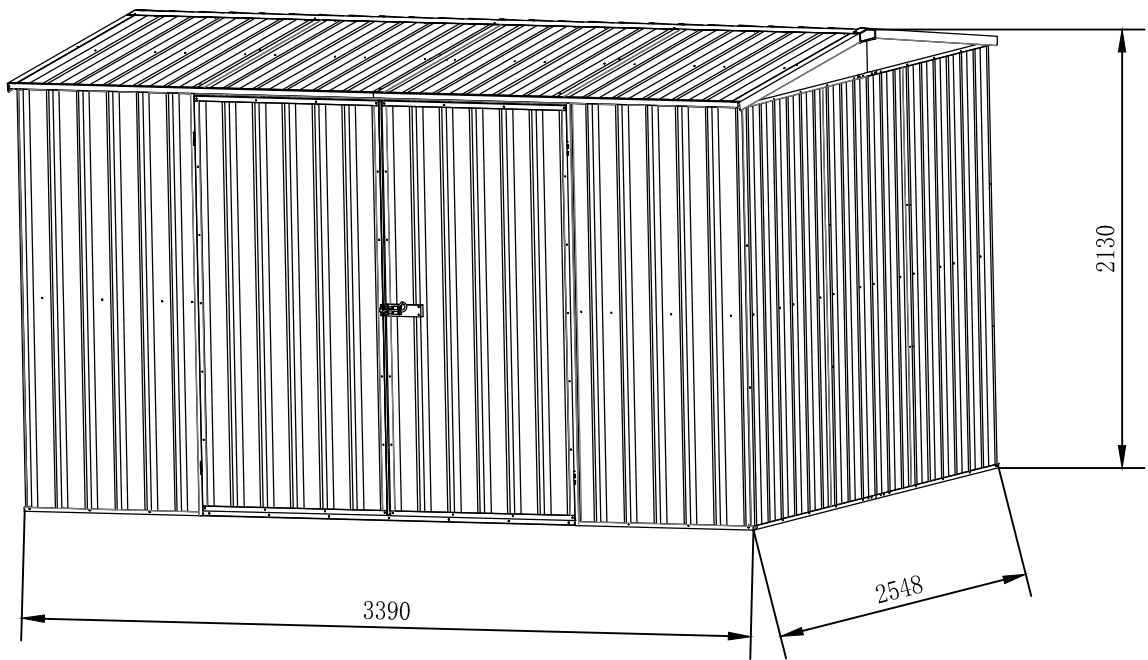

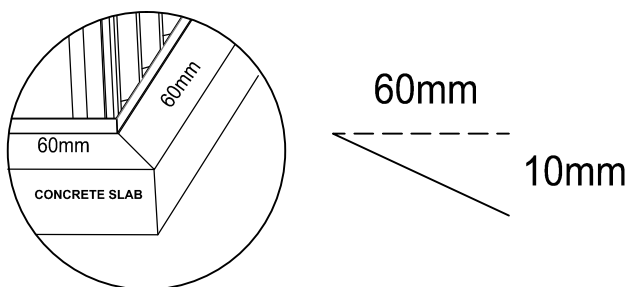



The concrete slab should be at least 3" to 4" (8-10cm) thick. It must be level and flat to provide good support.

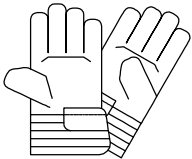

RECOMMENDED SLAB SIZE: 3530mm × 2690mm

BEFORE YOU START

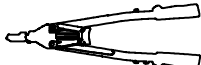
Items Required:

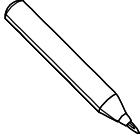
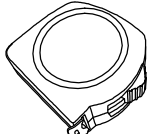







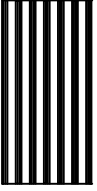
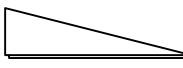
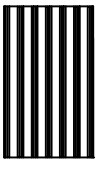
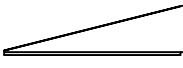
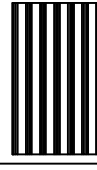
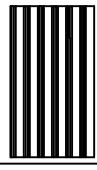
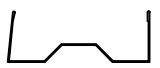
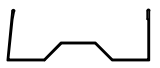

Safety Gear				
	gloves	Safety Glasses	Shoes	Riveting Gun
Tools				
	Power drill	Screw driver	Pencil	Tape Measure

- Clear a working area to allow access on 4 sides. A raised work surface will make assembly easier.
- All parts are identified so when working through the instructions page by page the diagrams show where each part is positioned.
- Many of the holes have been pre-punched, to allow fixing using self-tapping screws or rivets, where additional holes are required a drill bit is included.
- Before starting, to avoid any accidental injury, we recommend the use of gloves to protect your hands, safety glasses to protect your eyes and shoes or boots to protect your feet.
- Please keep children away from your construction site.
- Most assembly can be completed by one person, assistance may be needed when you reach the erection stage.
- Please note: Some local government authorities have rules & regulations on shed installation and you may need approval to erect this shed.



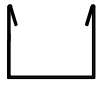

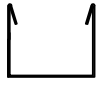
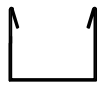



STEPS:

1. Unpack all components from the carton and lay outside your work area and check parts against the part list on the next page.
2. **Tip:** Parts are identified with letters T=Top, U=Up, M-Middle, B= Bottom use these as a guide for where the parts go.
3. Refer to page "HOW PANELS ARE JOINED", the unique clipping method reduces the number of screws and rivets required and speed up assembly.
4. Work through assembly instructions Page by Page
5. When completed place shed in position and anchor securely to the ground.
6. Clean up all metal pieces, rivets and screws.



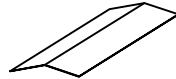
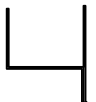
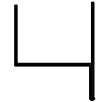
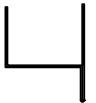









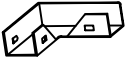







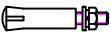

PART LIST

Picture	Part No.	QTY	Check	Picture	Part No.	QTY	Check
	PC2	10			GL3	2	
	TP1	8			GR3	2	
	DPC1	2			PC5	2	
	BB1	4			BB2	4	
	MF3B	4			BF5F	2	
	BF7A	2			UF5F	2	
	MF4B	2			UF7A	2	
	MF1F	2			UF3A	2	
	UF4A	2			BF3A	4	

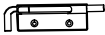
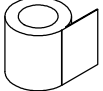
PART LIST

Picture	Part No.	QTY	Check	Picture	Part No.	QTY	Check
	LT2	4			BF11	1	
	DFC2	2			DF1	4	
	DFC3	2			TR3	4	
	MTC1	2			DTC	1	
	T2	1			MS3	2	
	DFU1	2			DFU2	4	
	LT1	4					

PART LIST

Picture	Part No.	QTY	Check	Picture	Part No.	QTY	Check
	J3	11			C12	8	
	C1	8			C23	4	
	S3	311			S5	176	
	S16	30			L1	2	
	C7	10			S8	36	
	S11	10			UF1	4	
	UF6	2			UF7	2	
	L3	90			H1	1	
	H2	1			H3	1	
	Waterproof tape	1			MSA	4	
	LG3	2			SH1	4	
	L1A	12			H1B	1	
	S1	2			Rust zinc block	2	

ANALYSIS DIAGRAM

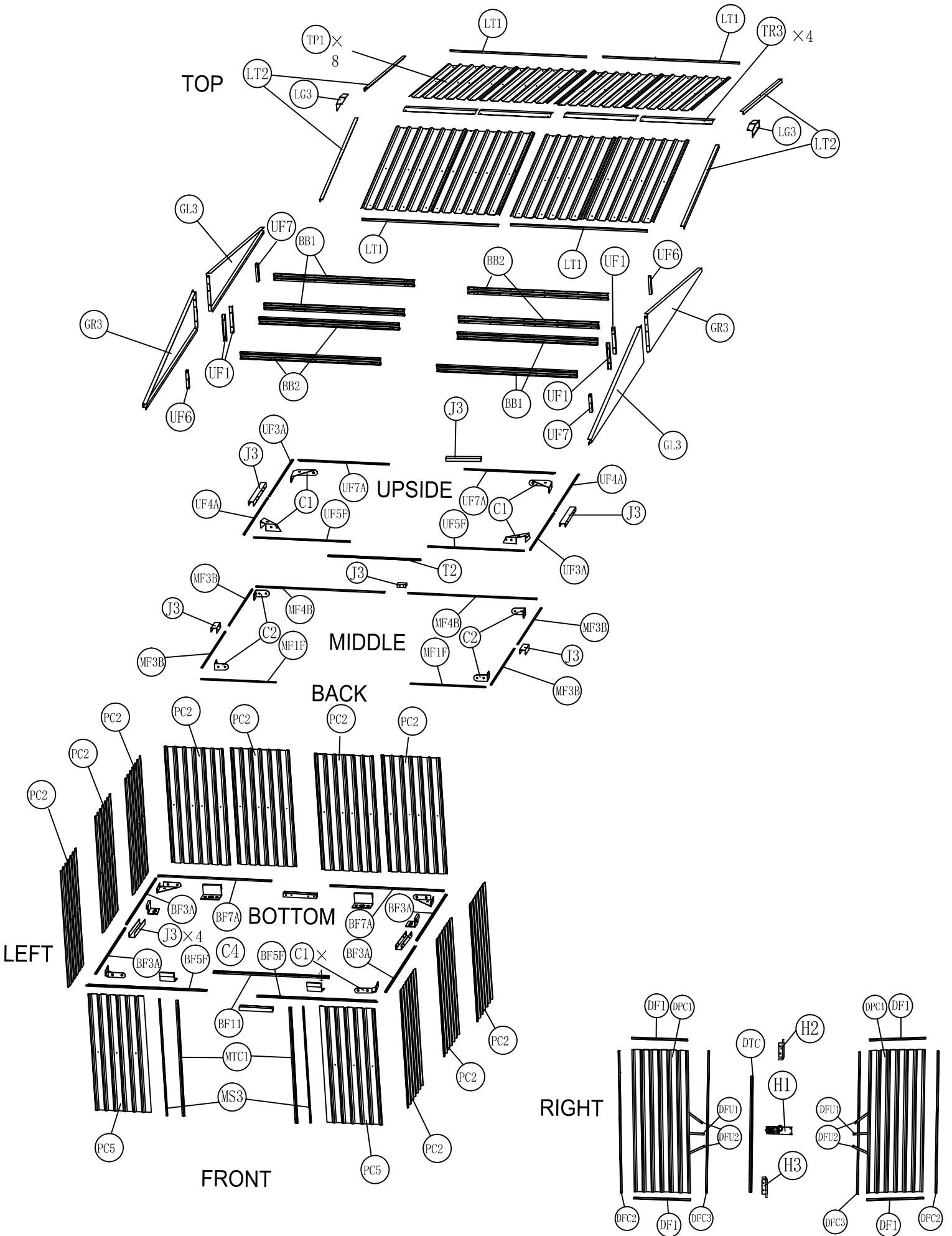

HOW PANELS ARE JOINED

PUSH position channel over one end of the sheets, working along the sheets to the other end.

It installs more easily if panels spreads on the table

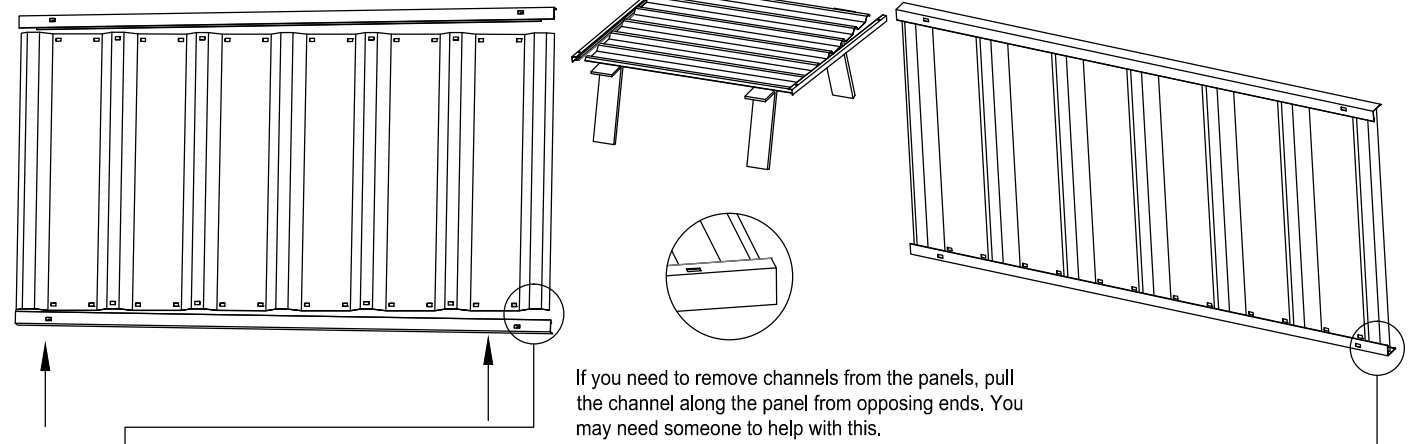

If you need to remove channels from the panels, pull the channel along the panel from opposing ends. You may need someone to help with this.

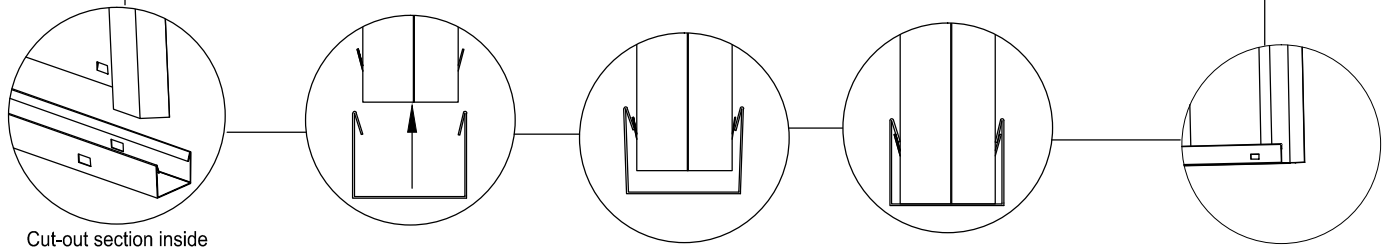

INSTRUCTIONS FOR JOINING SPLICED CHANNELS

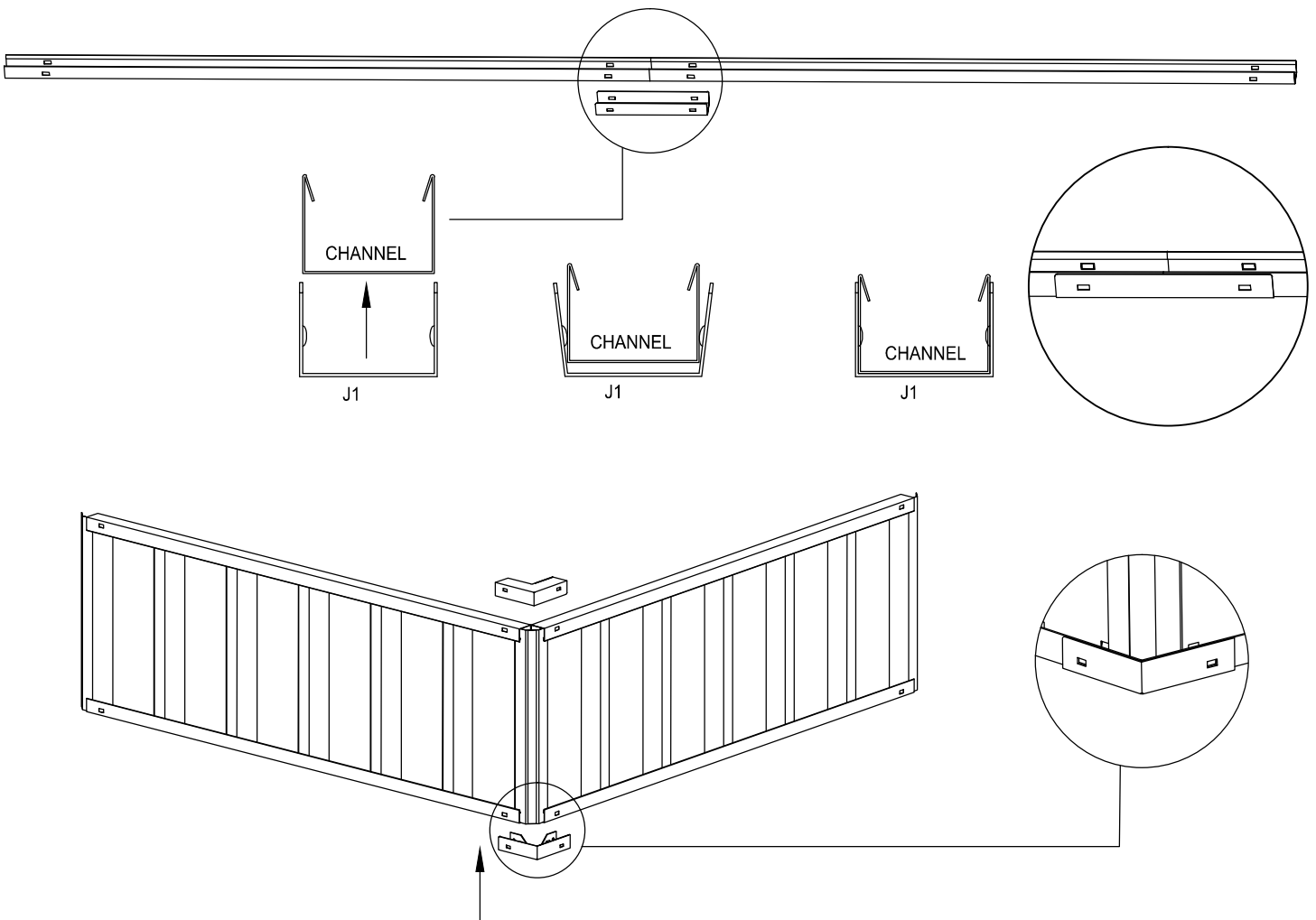

WALL ASSEMBLY

LEFT AND RIGHT WALL ASSEMBLY

STEP 1.

	PC2	3
	BF3A	2
	J3	2
	UF3A	1
	UF4A	1

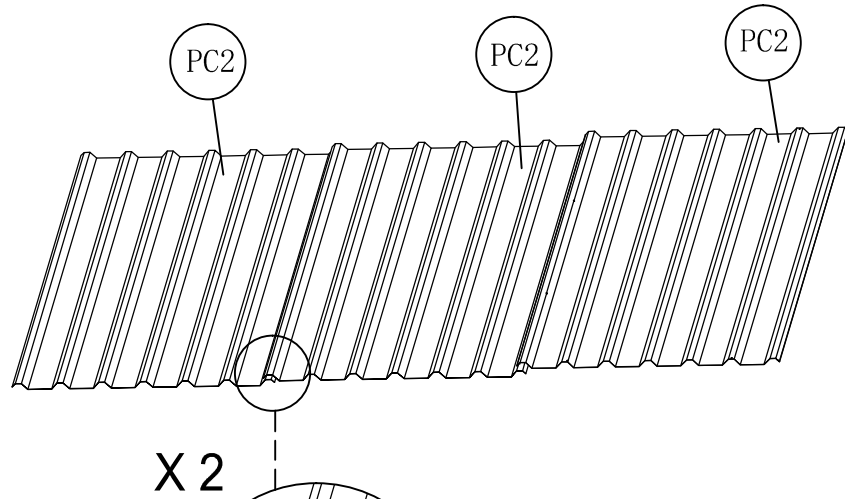

Note the direction of the hole.

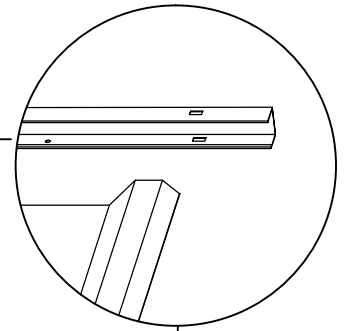
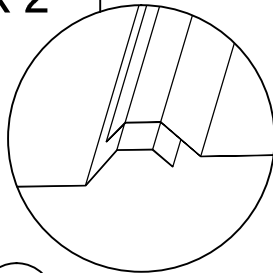
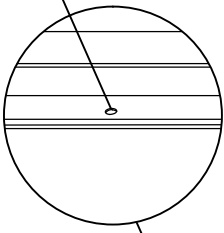

STEP 2.

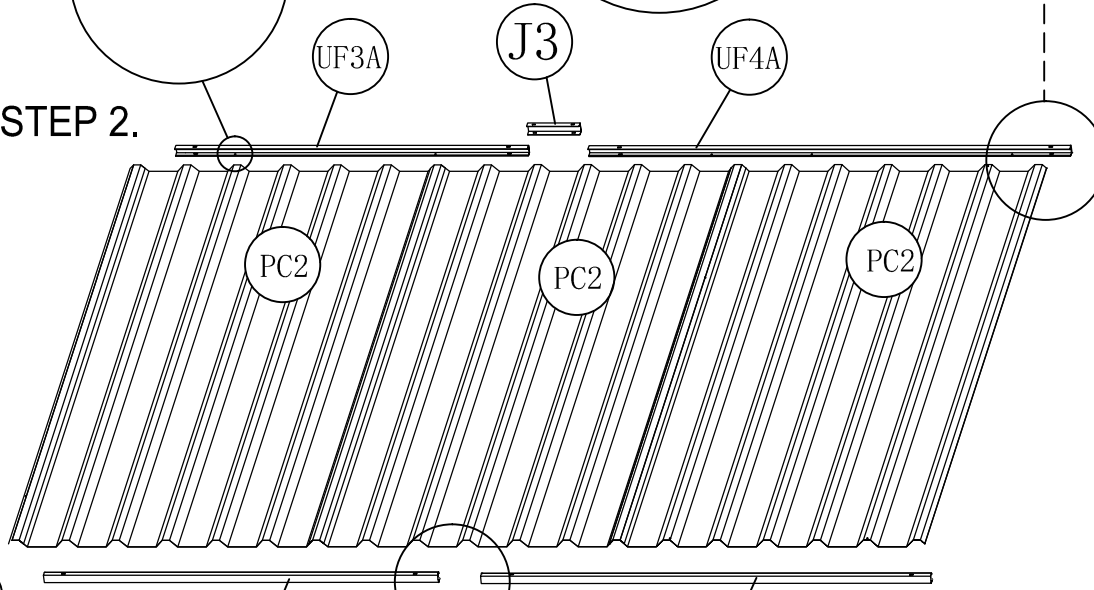

Make sure the joint of the two U channels are aligned with the center line where the corresponding two wall panels overlap.

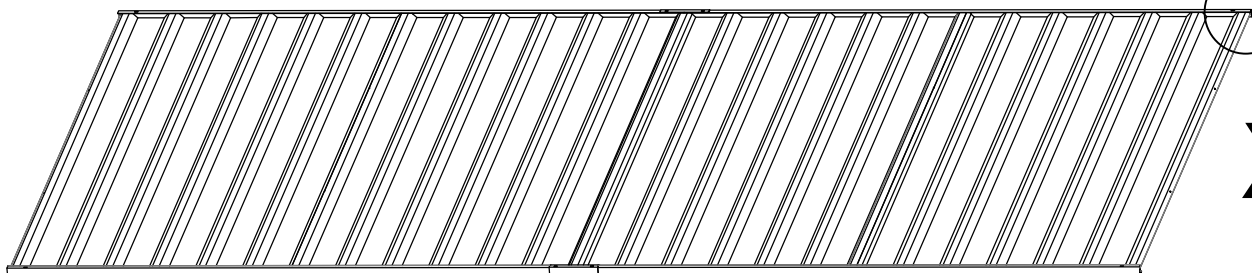
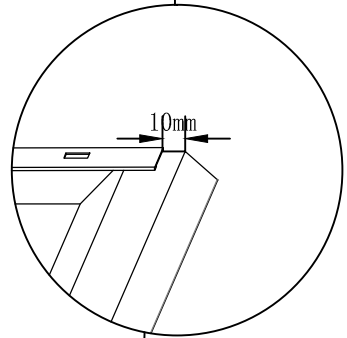

X 2

BACK WALL ASSEMBLY

STEP 1.

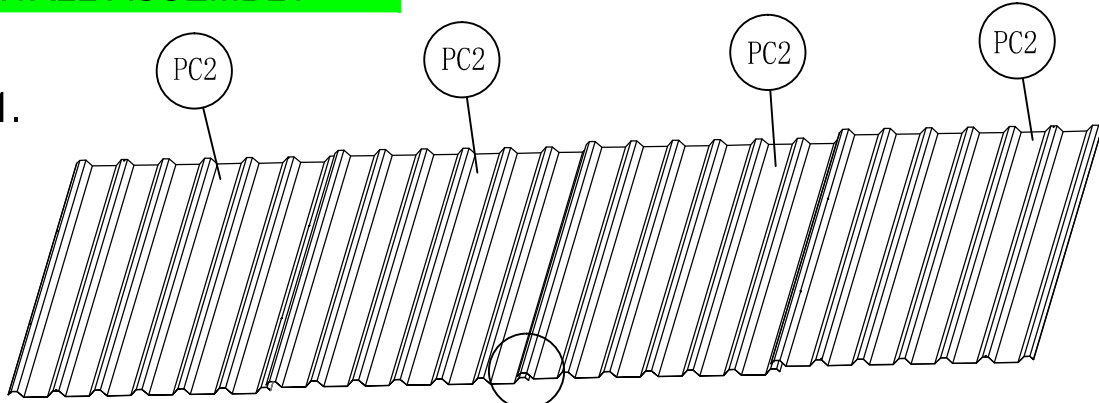

	PC2	4		UF7A	2
	BF7A	2		J3	2

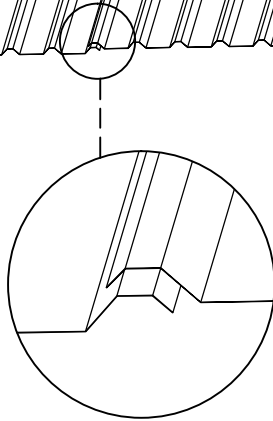

STEP 2.

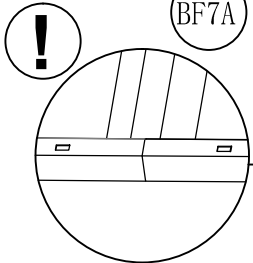
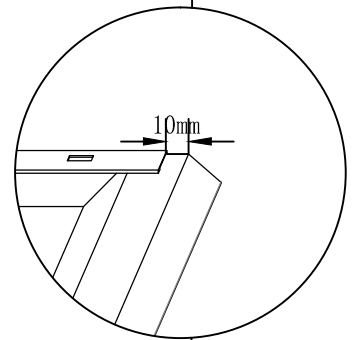
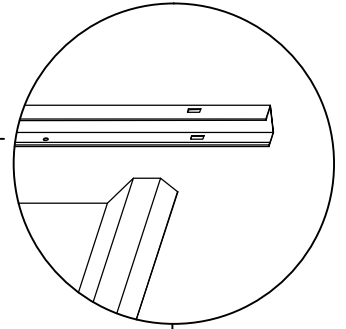
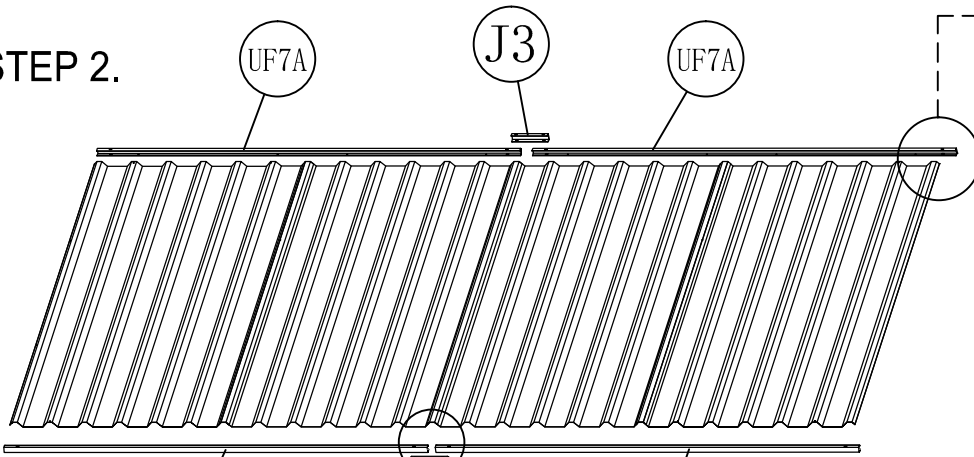



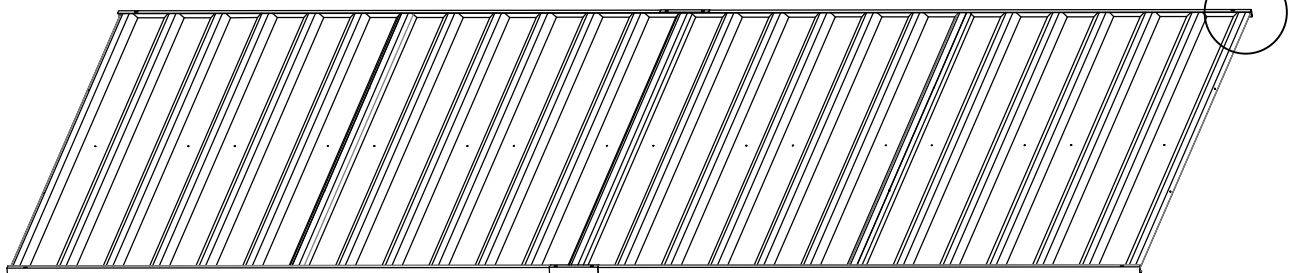

Make sure the joint of the two U channels are aligned with the center line where the corresponding two wall panels overlap.



WALL ASSEMBLY



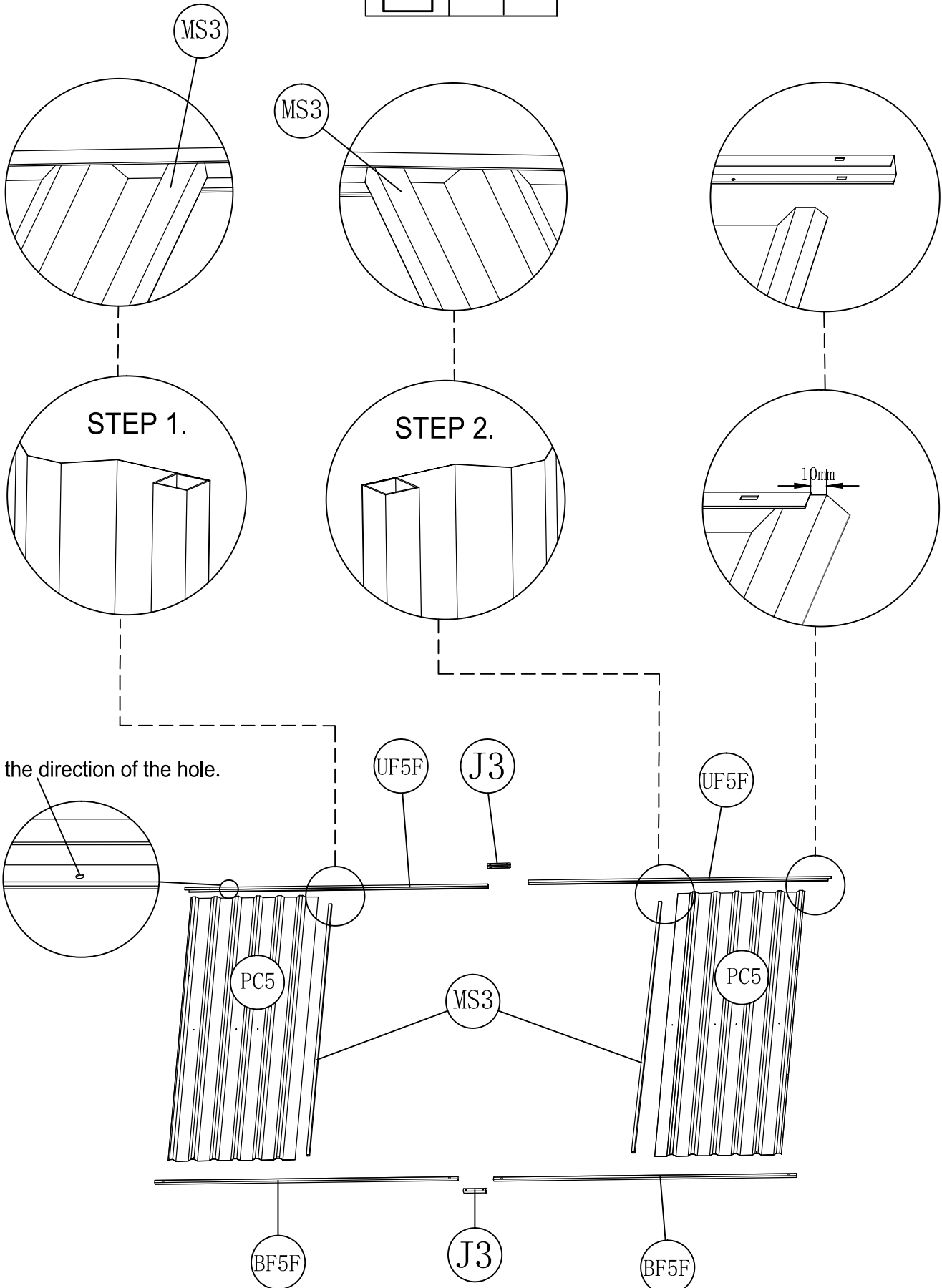

FRONT WALL ASSEMBLY

	PC5	2		BF5F	2
	MS3	2		J3	2
	UF5F	2			



WALL ASSEMBLY





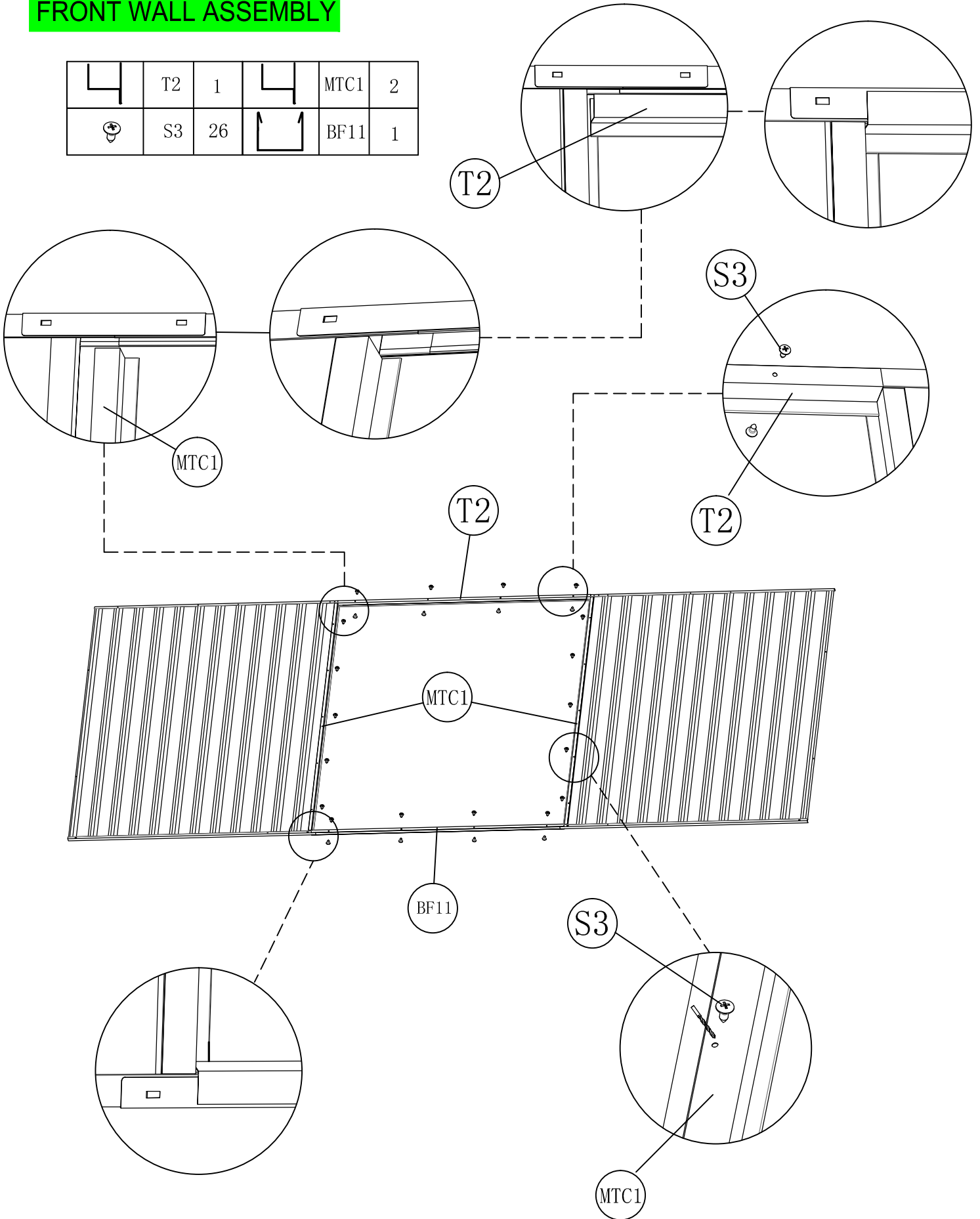

FRONT WALL ASSEMBLY

	T2	1		MTC1	2
	S3	26		BF11	1







DOOR ASSEMBLY

Left Door

	DPC1	1		DF1	2
	DFC2	1		DFC3	1
	DTC	1		S3	4
	C12	4			

Right Door



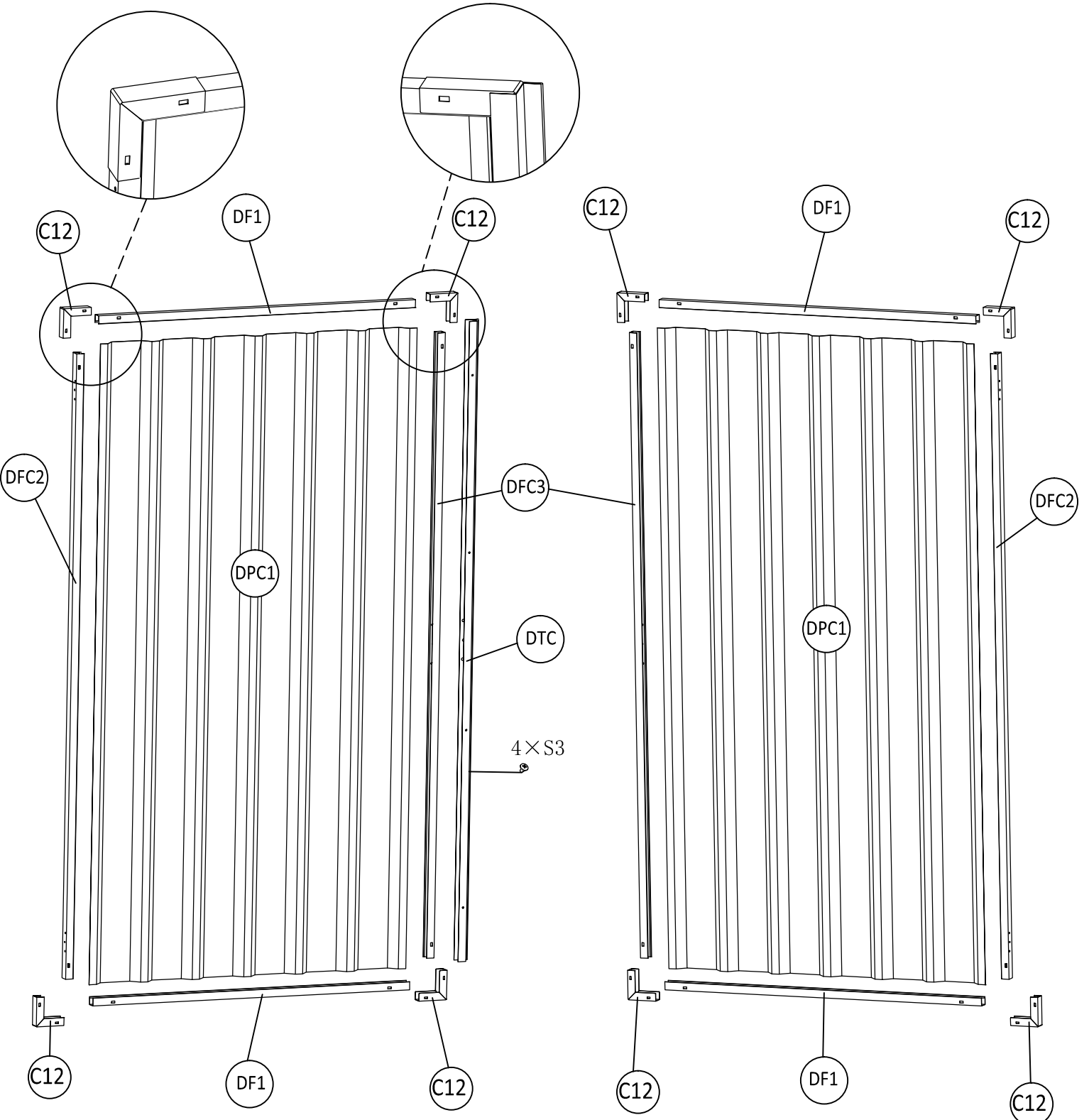

	DPC1	1		DF1	2
	DFC2	1		DFC3	1
	C12	4			







DOOR ASSEMBLY

Left Door

Right Door

	DFU1	1		DFU2	2
	S3	6		L1A	6



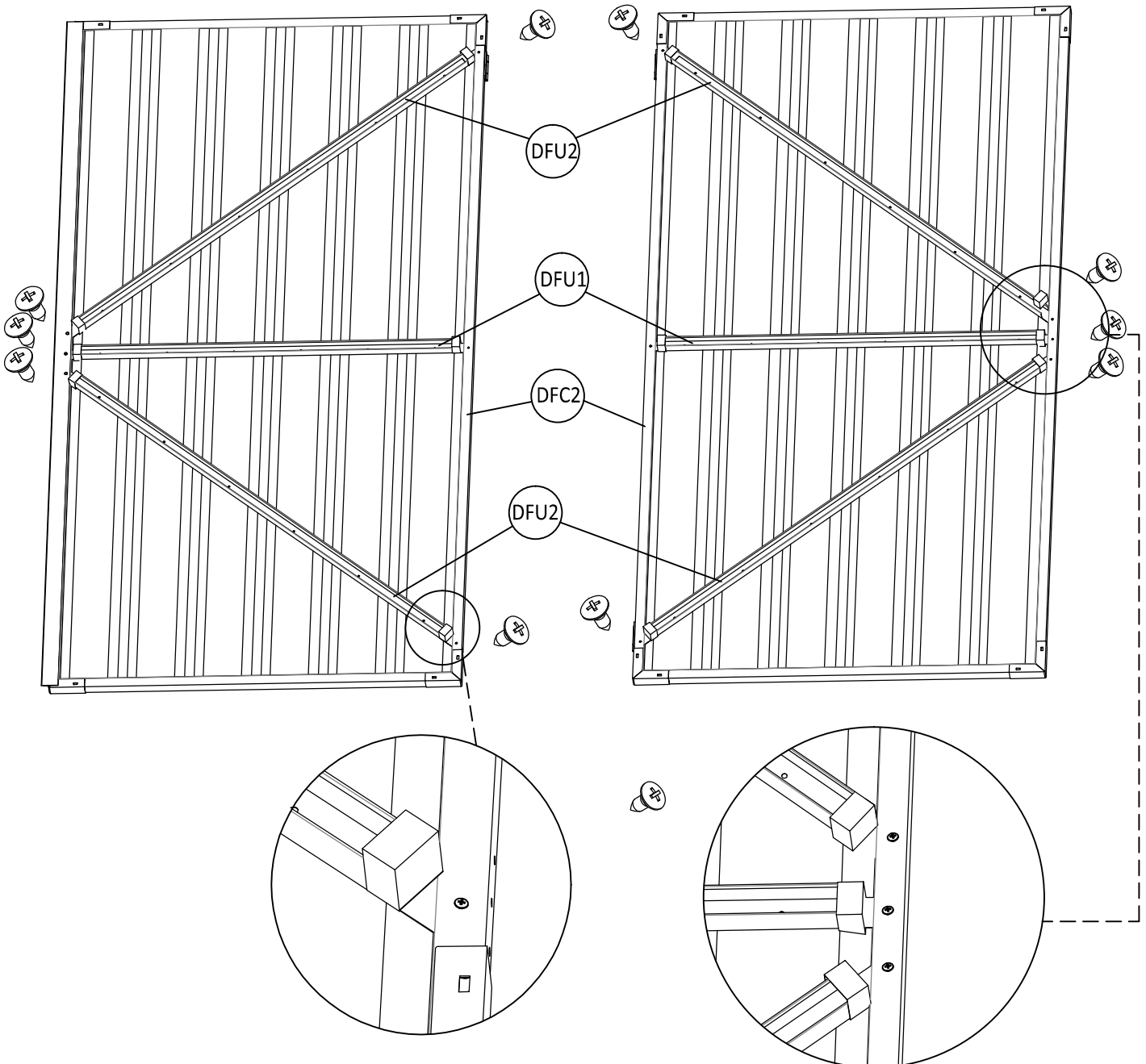
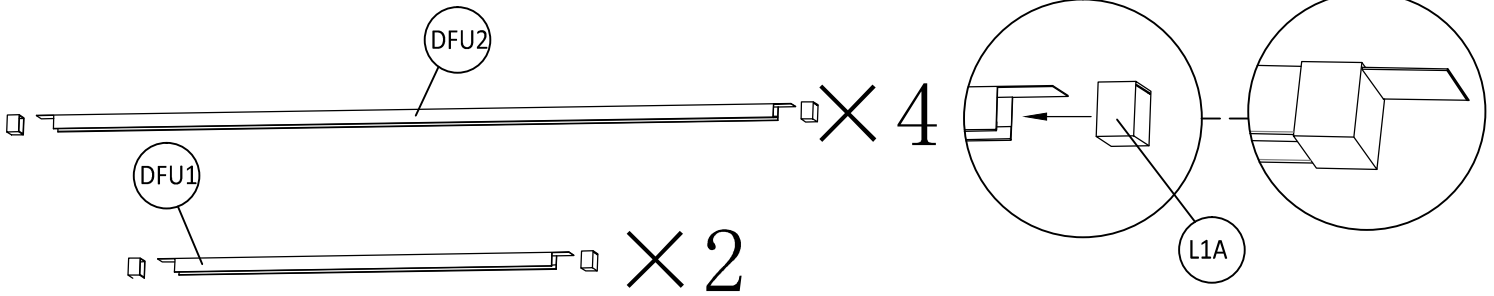



	DFU1	1		DFU2	2
	S3	6		L1A	6



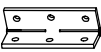



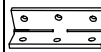

DOOR ASSEMBLY

Left Door

Right Door

	SH1	2		S3	18
	S16	6		L3	18
	MSA	2		S5	18

	SH1	2		S3	18
	S16	6		L3	18
	MSA	2		S5	18

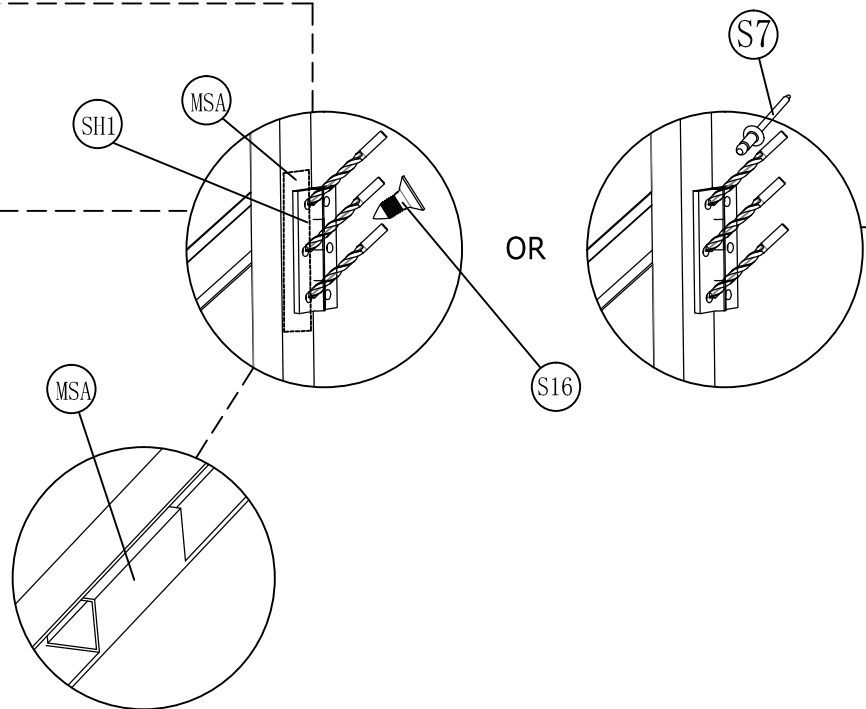
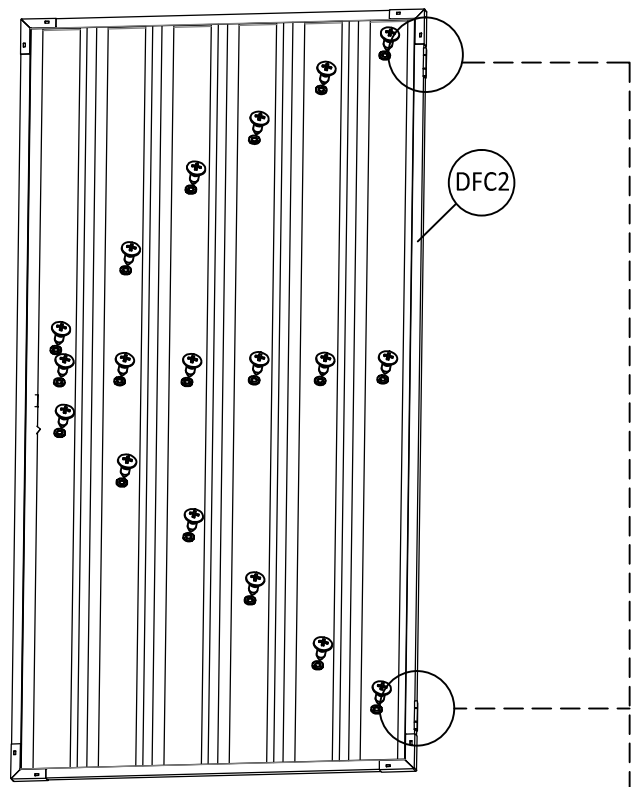
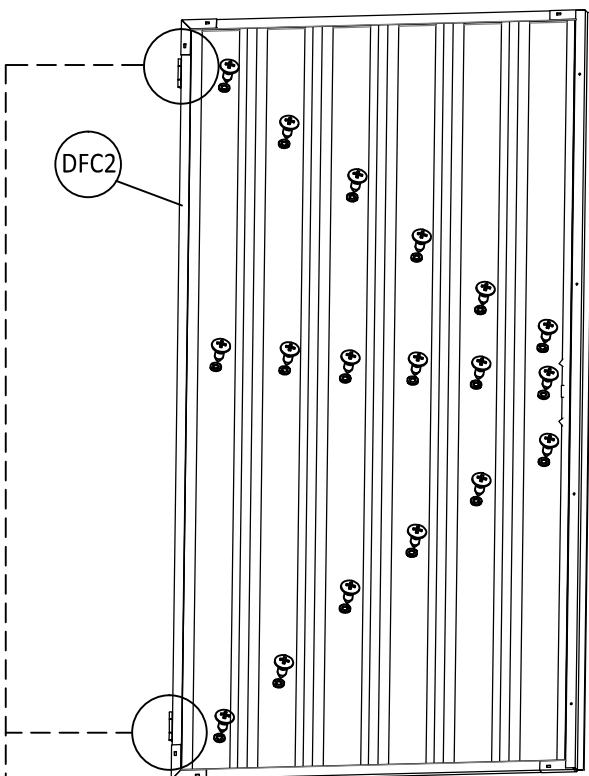

BEAM ASSEMBLY

LEFT & RIGHT ROOF BEAM ASSEMBLY

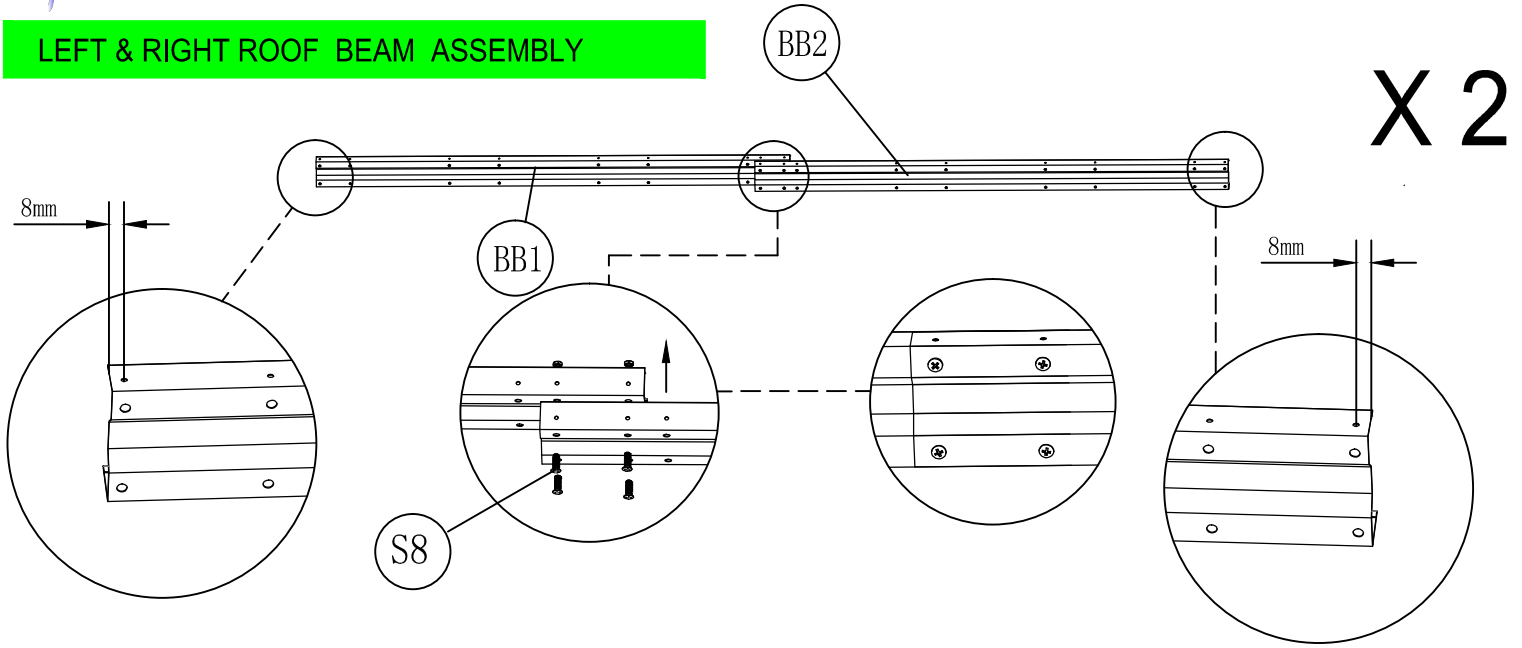

	BB1	1		BB2	1		S8	4	X 2
--	-----	---	--	-----	---	--	----	---	------------

Repeat assembly process , using parts layout shown.

CENTRE ROOF BEAM ASSEMBLY

Please noted, part of the holes on beam need to connect by S8

	BB1	2		BB2	2		S8	12
--	-----	---	--	-----	---	--	----	----

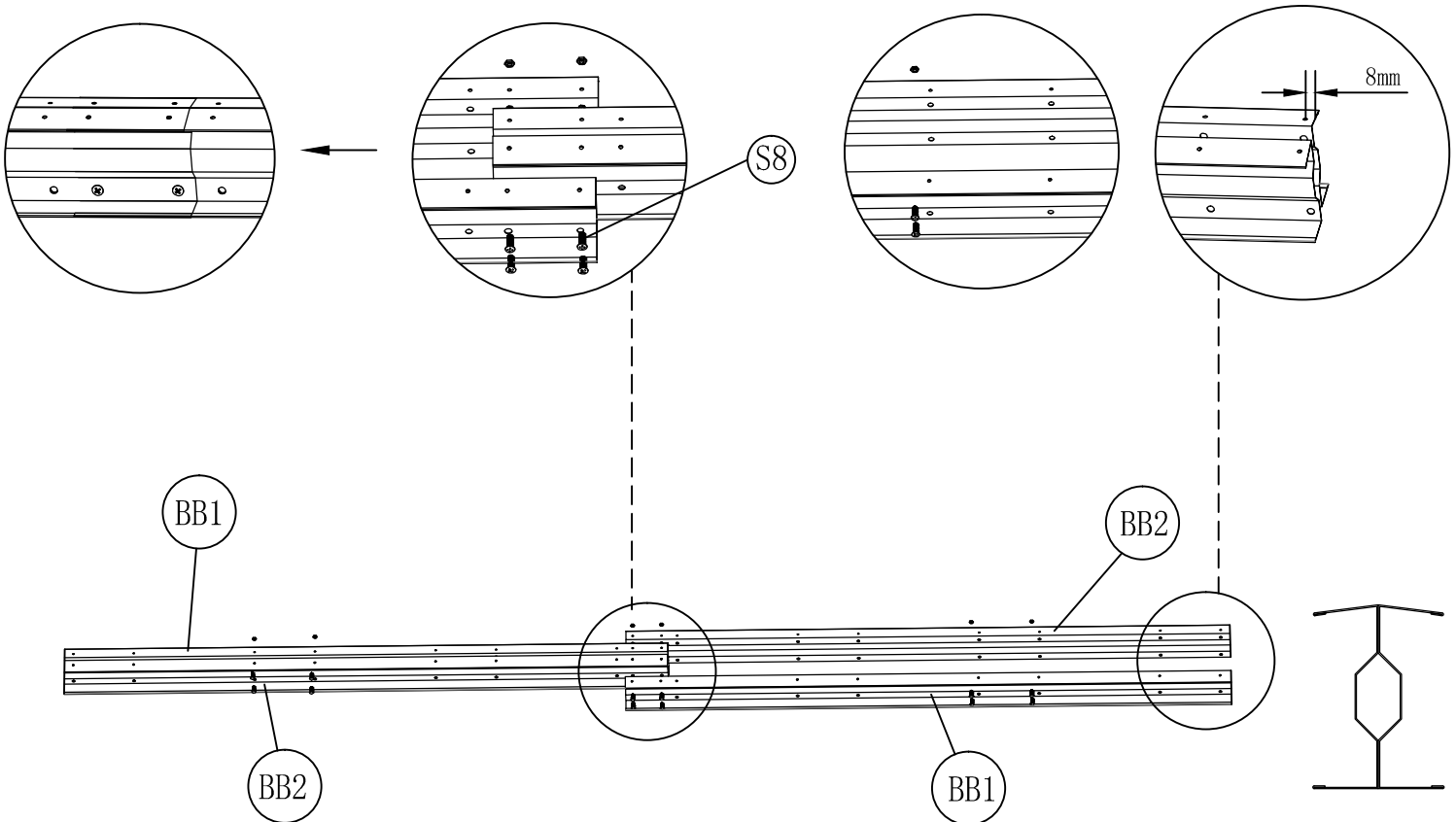







PANEL CONSTRUCTION

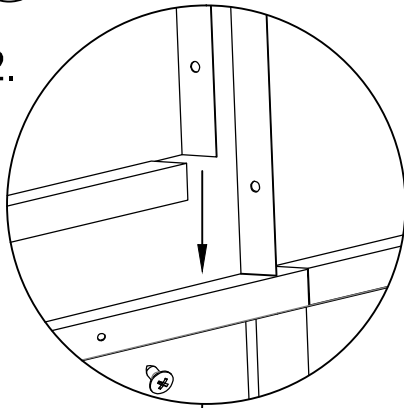

Ensure the correct location of up and down, when you install wallboard

STEP 2.





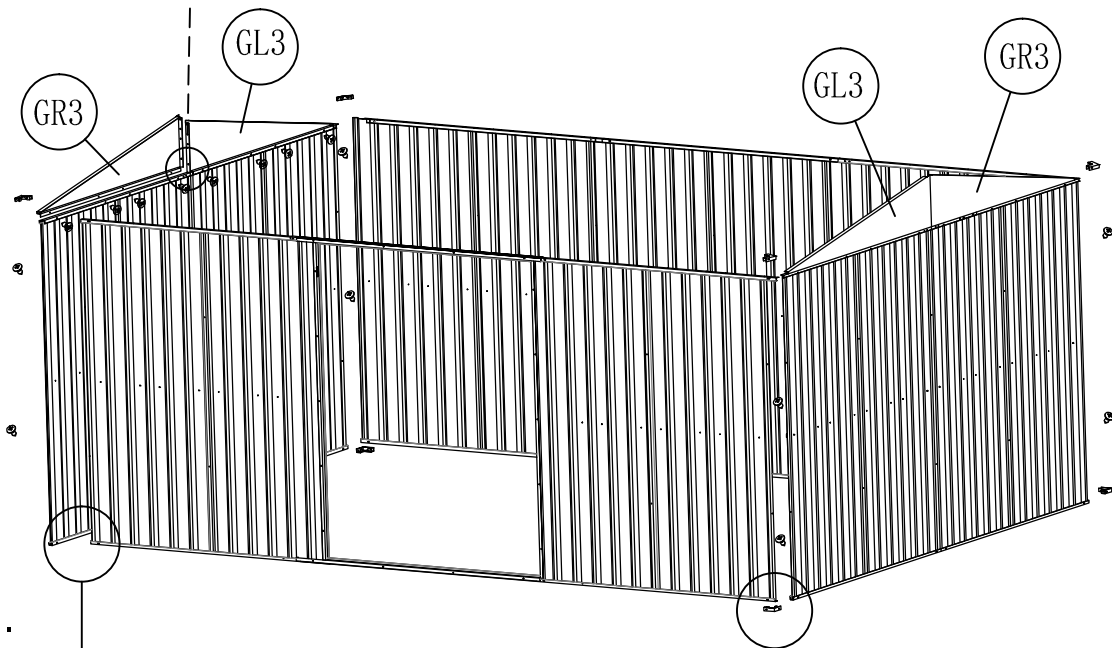



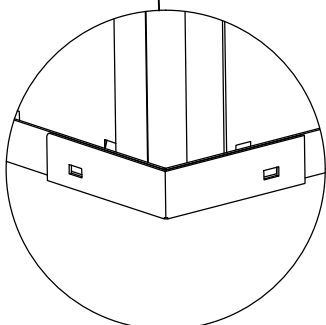
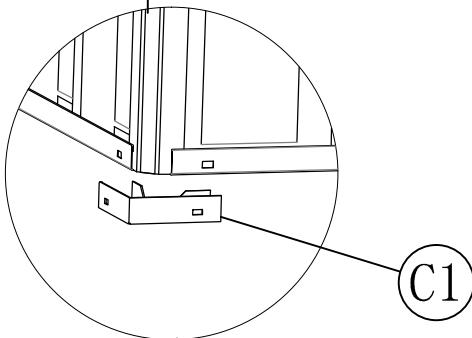

	GL3	2		GR3	2
	S3	20		L3	8
	C1	8			



STEP 1.



MONTAGGIO CASSETTA

	MF4B	2		J3	3		C23	4		S3	57		L3	38
	MF3B	4		MF1F	2		L1	2						

Use the holes of U channel drill new holes on the wall panel and fasten by using S3. Cap all S3 tips with L3.

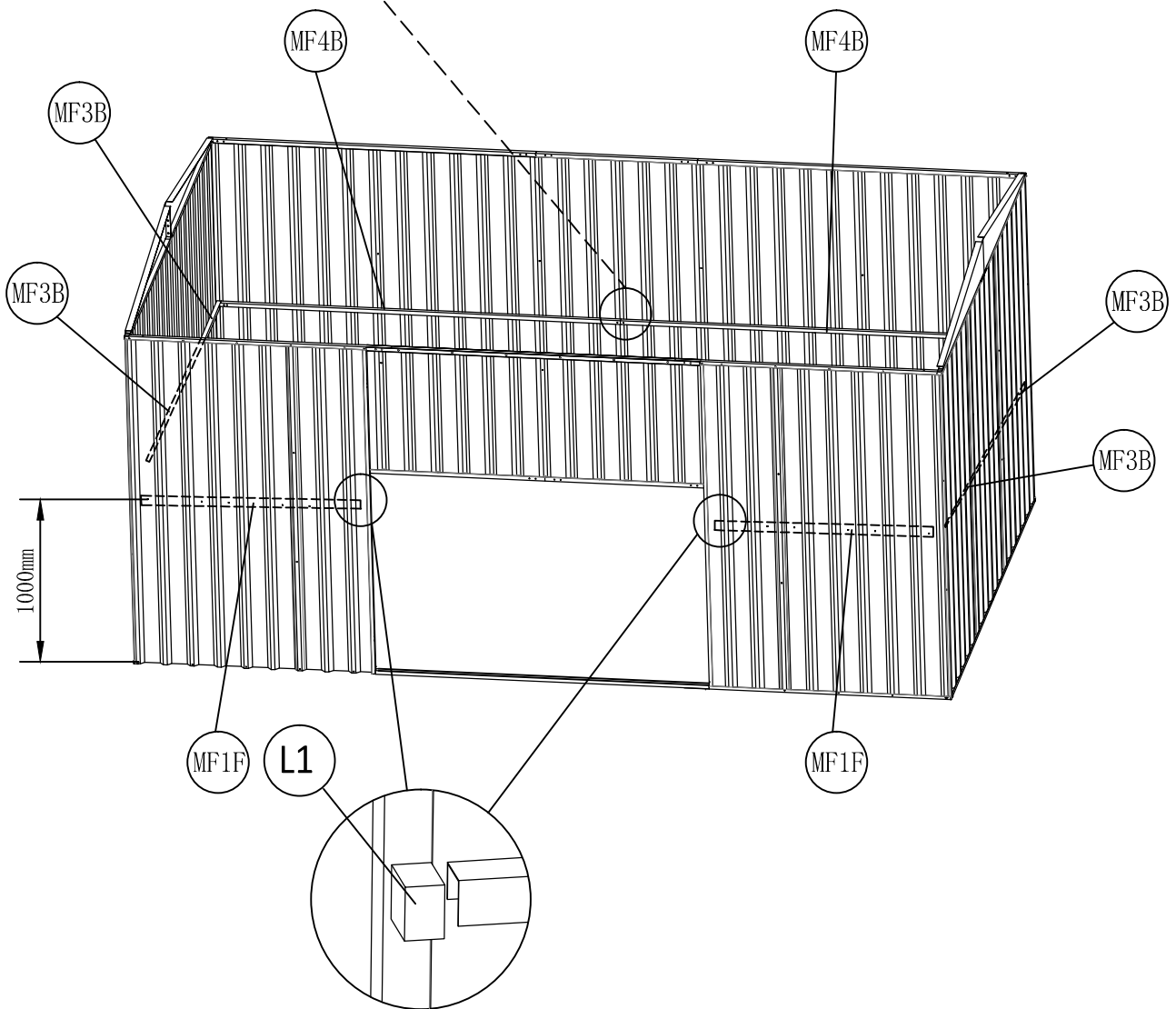
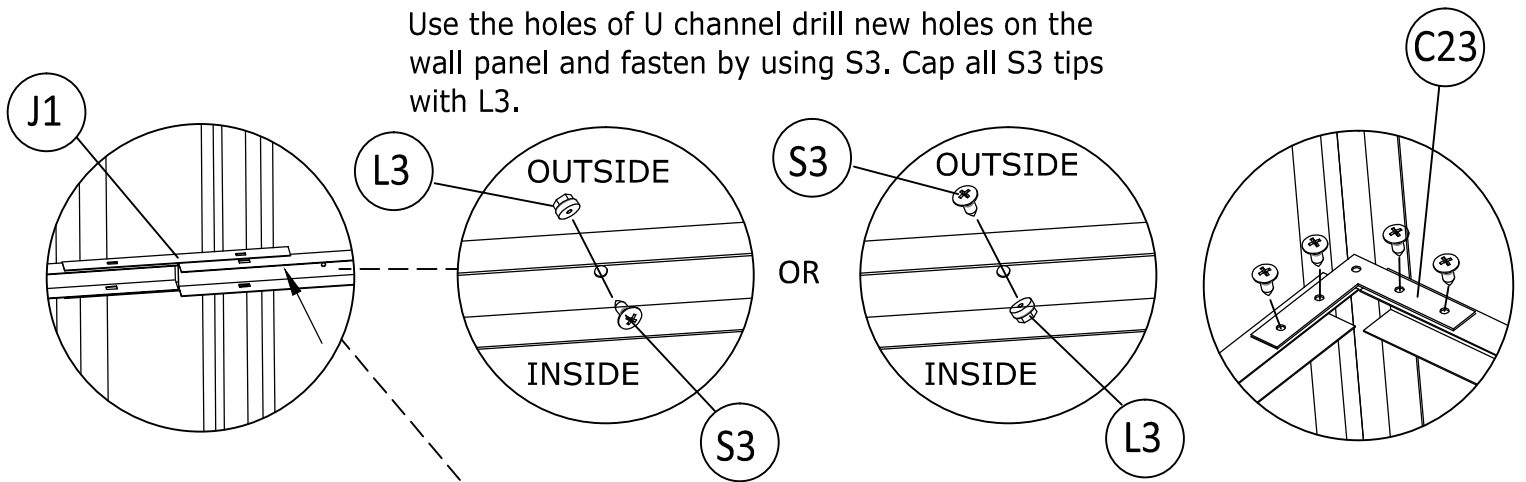

BEAM CONSTRUCTION

Beam Assembly Process:



1. Fix main beam
2. Put secondary beam on the roof, do not fix at this stage
3. Fix one left and one right roof panel on the roof, so the position of secondary beam can be confirmed by overlapping the holes on roof panel and secondary beam, then fix secondary beam.

	UF1	4		S8	8
--	-----	---	--	----	---

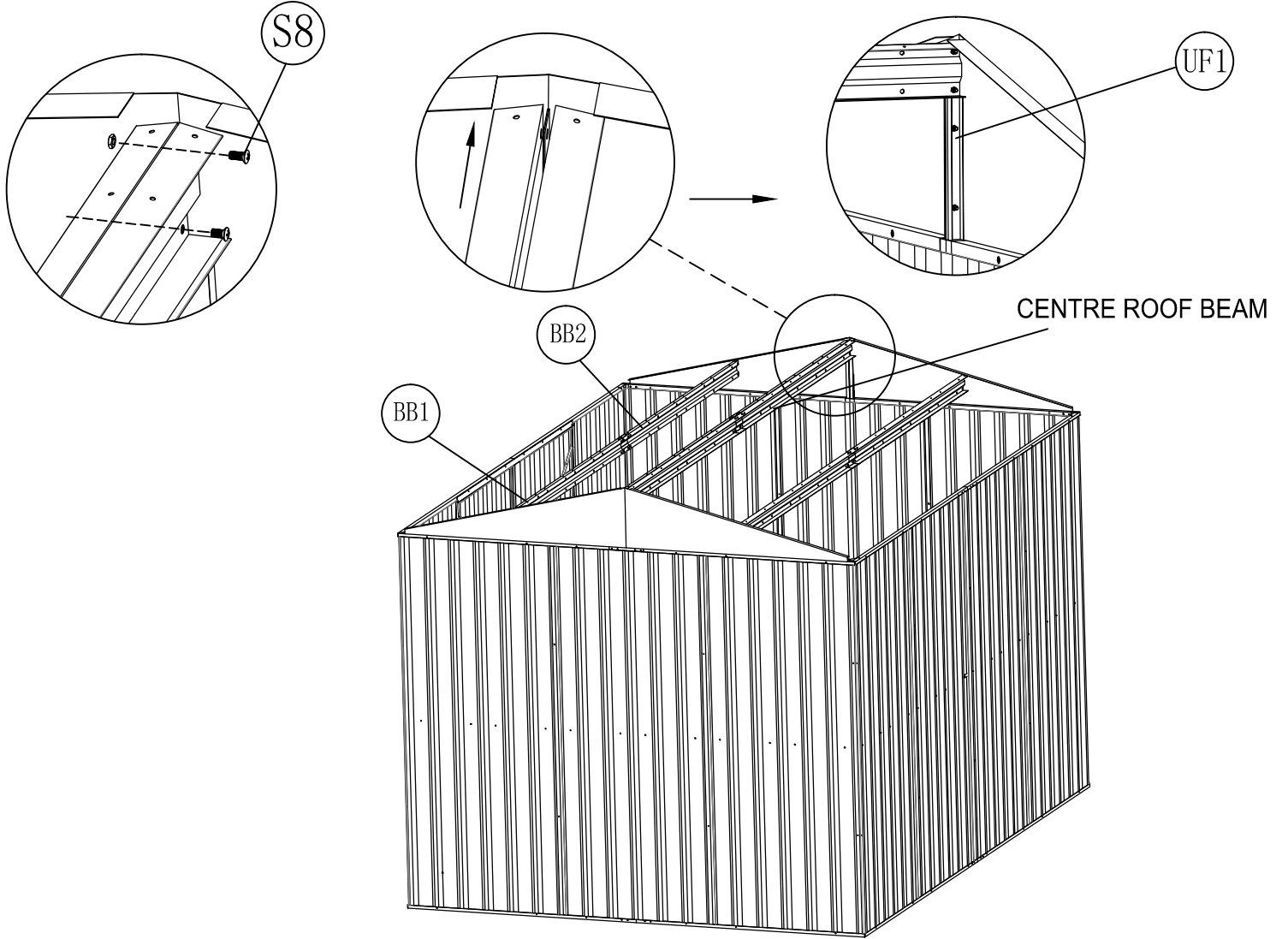



ROOF CONSTRUCTION

SECONDARY BEAM

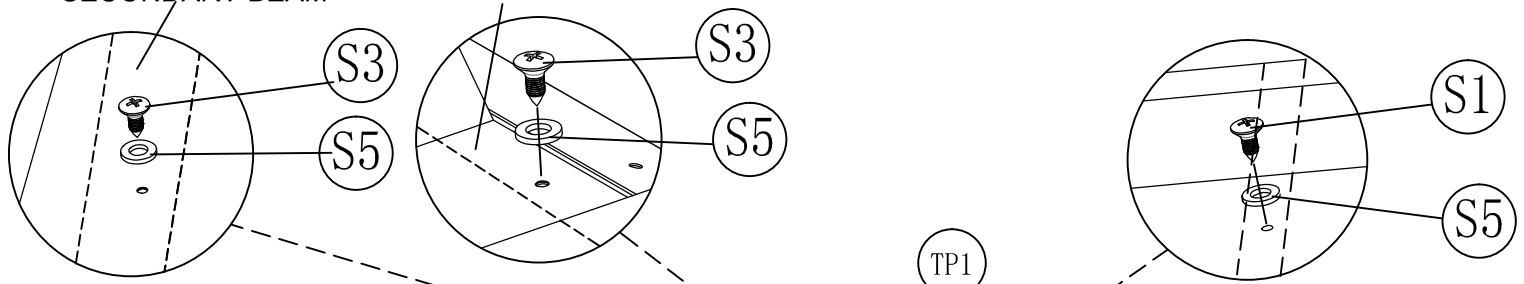
CENTRE ROOF BEAM





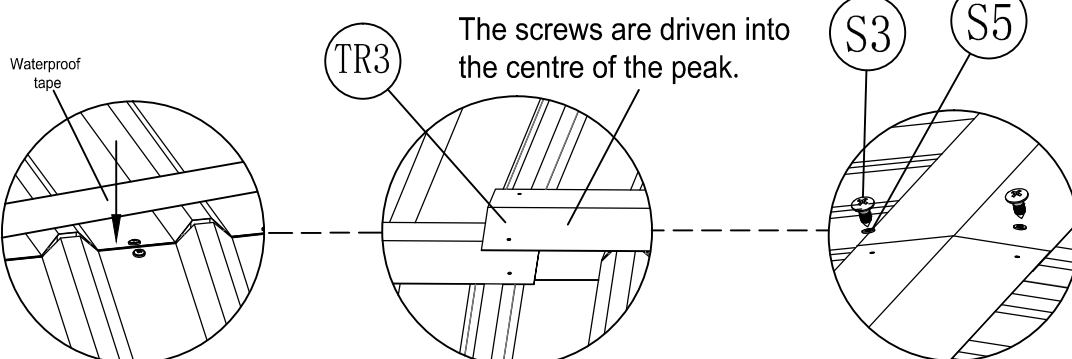
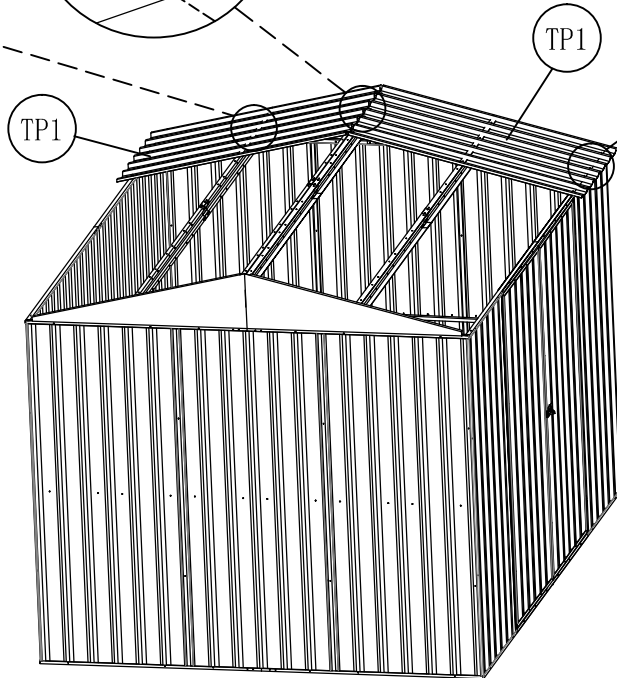

STEP 1.

	TP1	2
	S3	24
	S5	24



The screws are driven into the centre of the peak.



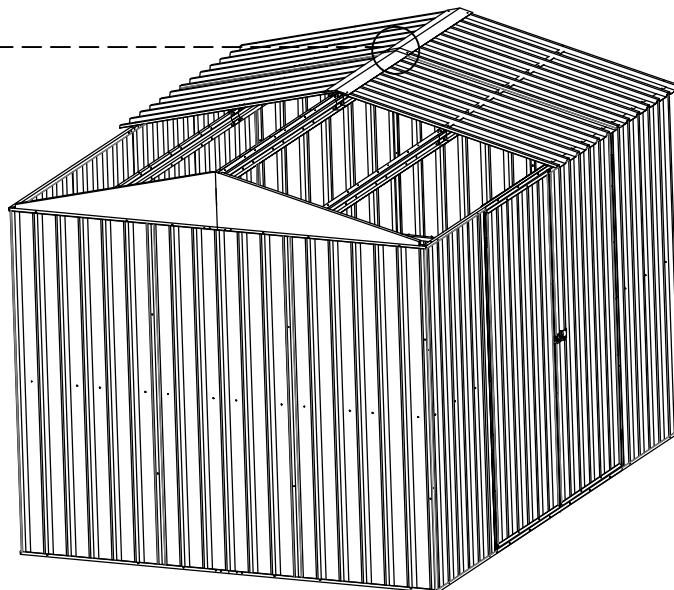

STEP 2.

	TR3	2
	TP1	2
	S3	30
	S5	30
	Waterproof tape	









STEP 3.

Use the same method to complete the other TPC5 boards and TR3.

	TP1	4
	TR3	2
	S3	60
	S5	60

ROOF CONSTRUCTION

STEP 4.

	UF6	2		UF7	2		L3	8
	S3	8		S5	8		S8	8

STEP 4.1.

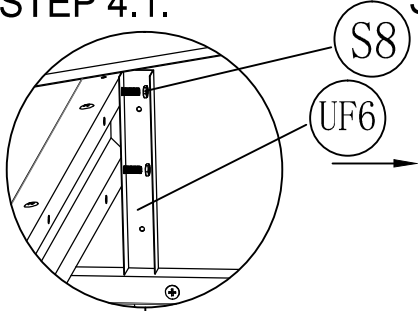

STEP 4.2.

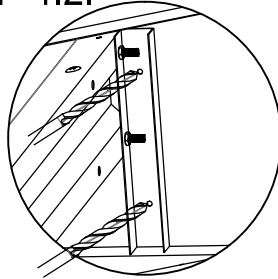



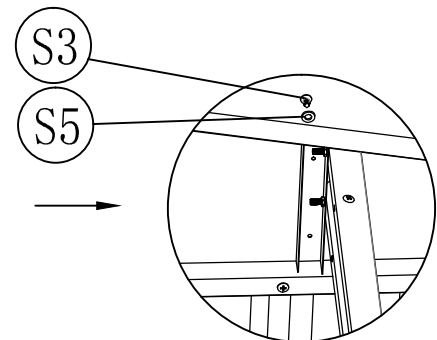
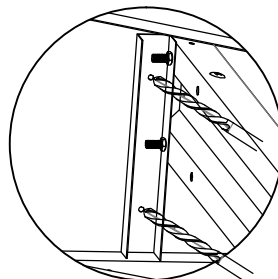
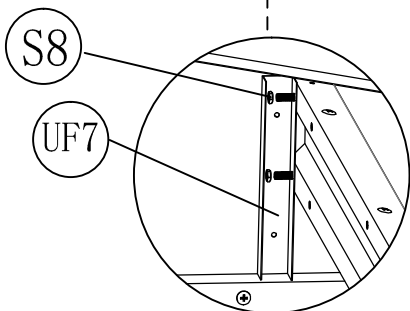
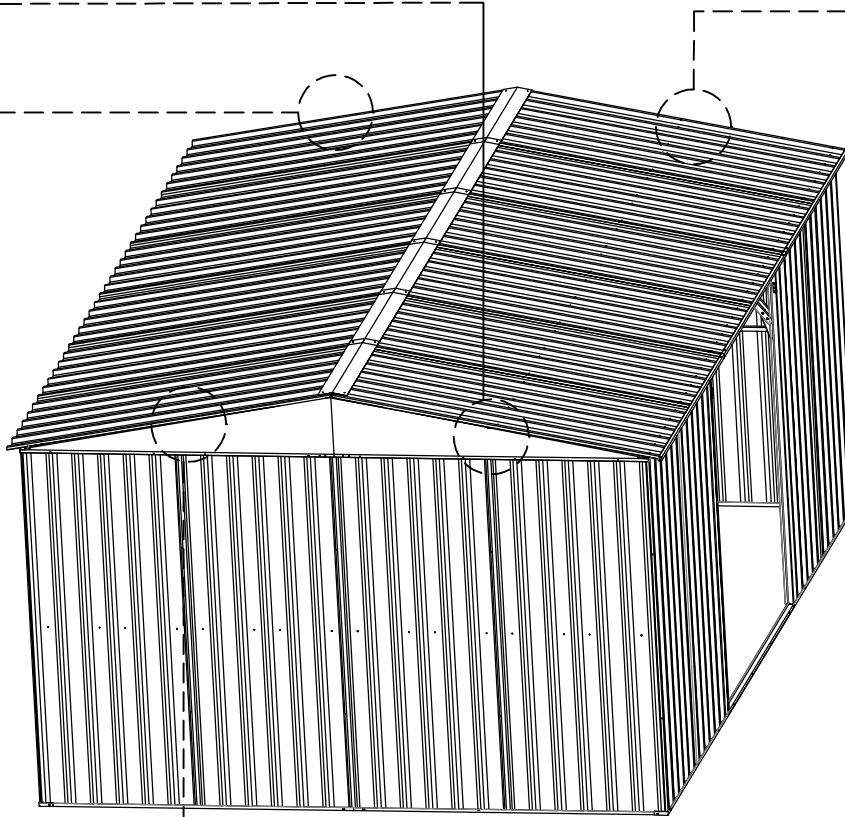
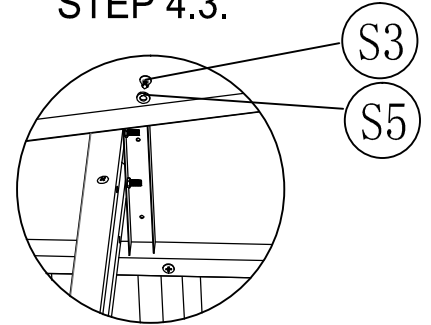

STEP 4.3.



ROOF CONSTRUCTION

STEP 5.

	LT1	4		LT2	4		LG3	2
	S3	18		S5	18			

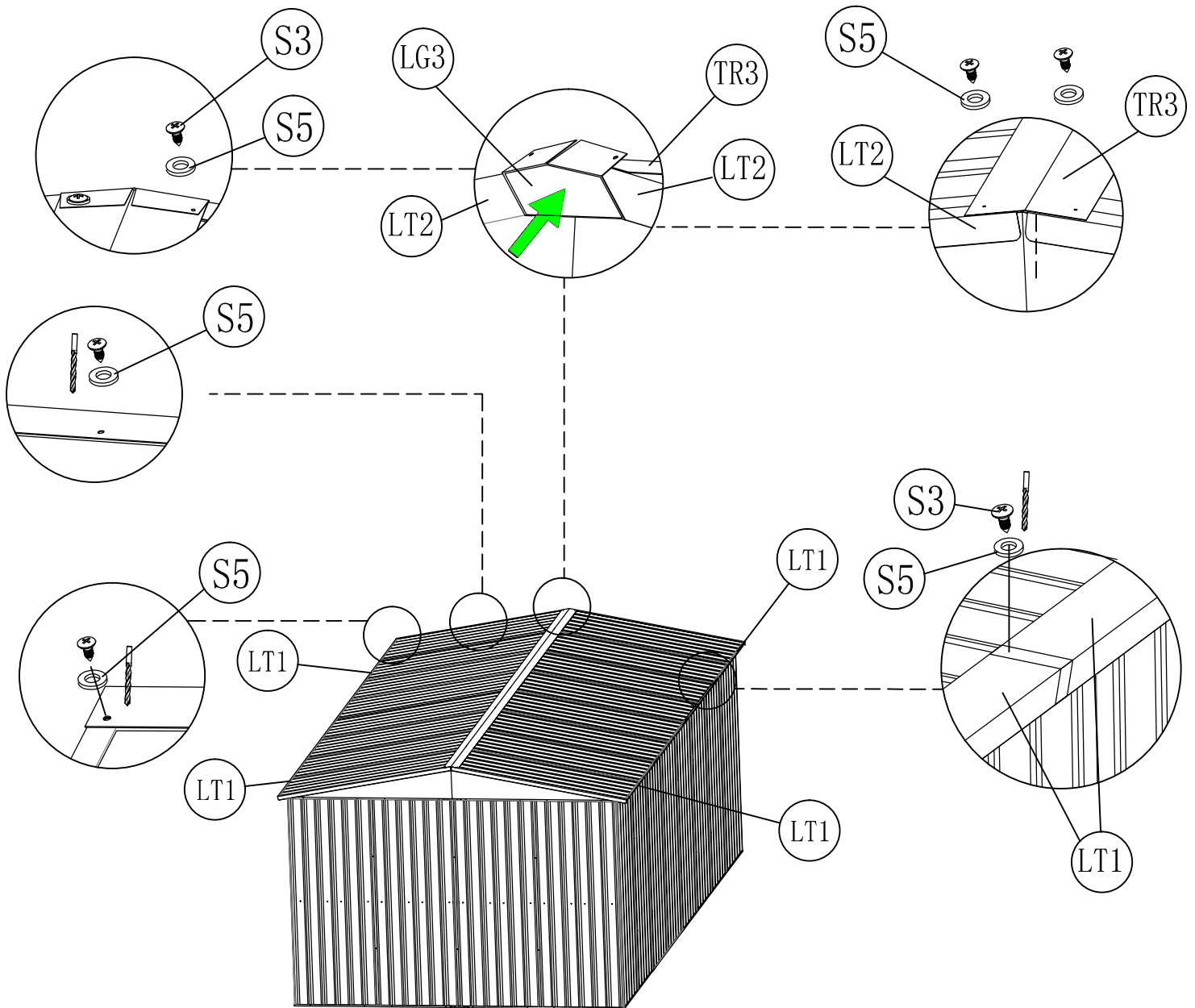

STEP 1.

Adjust the position of the door, mark on MTC1 and use the drill to drill through, then use S7 or S16 to connect.

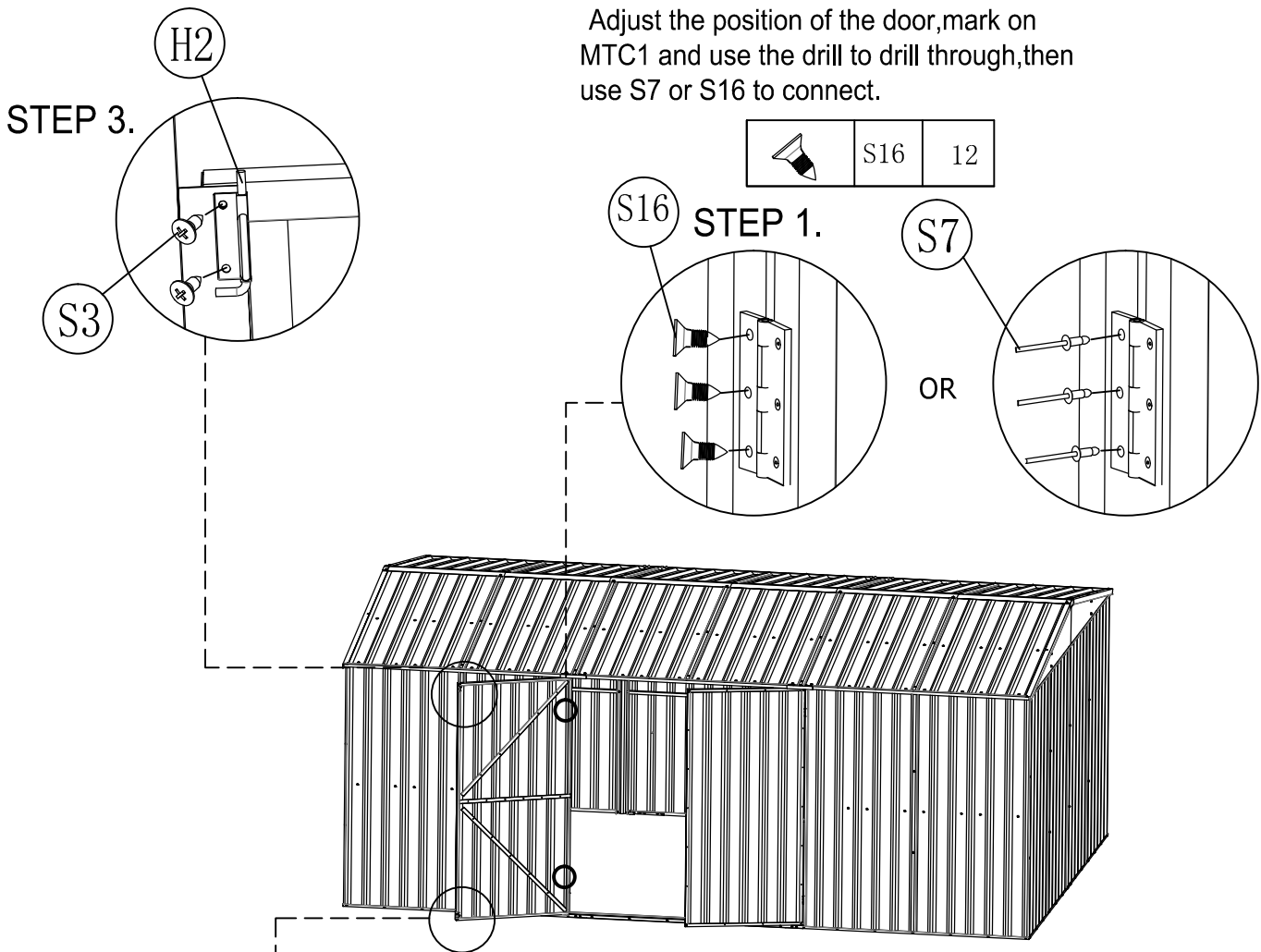

STEP 2.

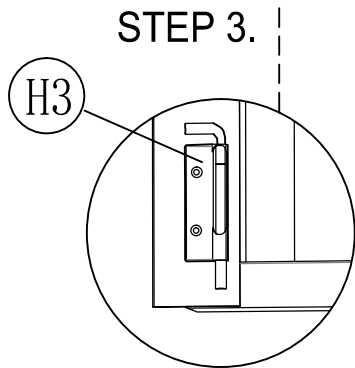

Adjust the door position until it opens and closes freely, Use the holes on MTC1, drill new holes and fasten using S3.

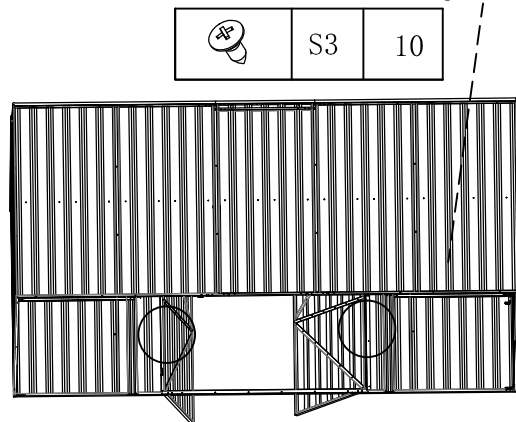

STEP 3.

Determine position of lower latch when the door is closed, mark the spot and drill holes, then fix with S3.

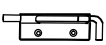
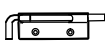



	H2	1		H3	1
	S3	4			

DOOR CONSTRUCTION

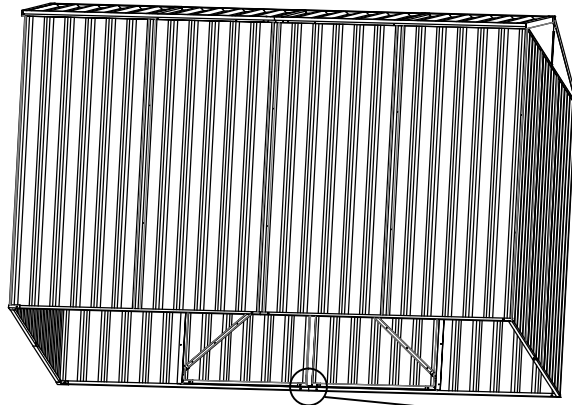
STEP 3.



	H1B	1
	S3	2

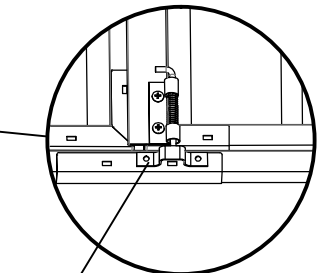

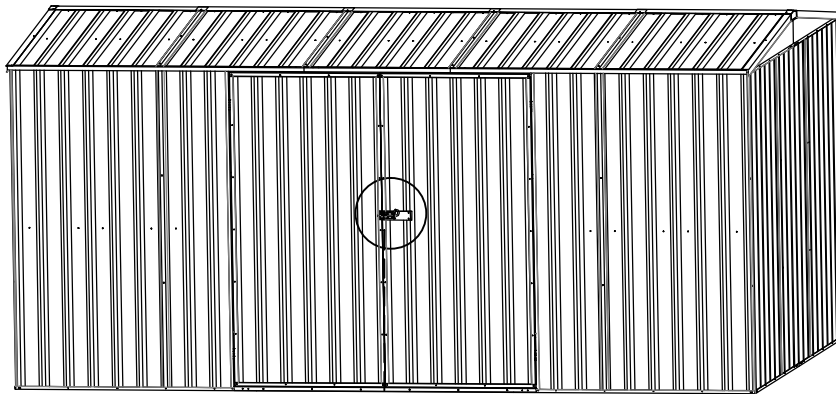

STEP 4.



H1B

Install the latch in position as shown and fix with S16 or S7.

	H1	1
	S16	6

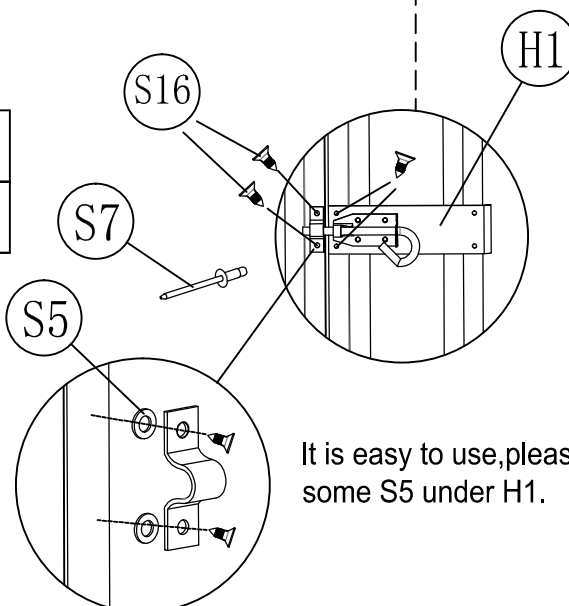

It is easy to use, please add some S5 under H1.

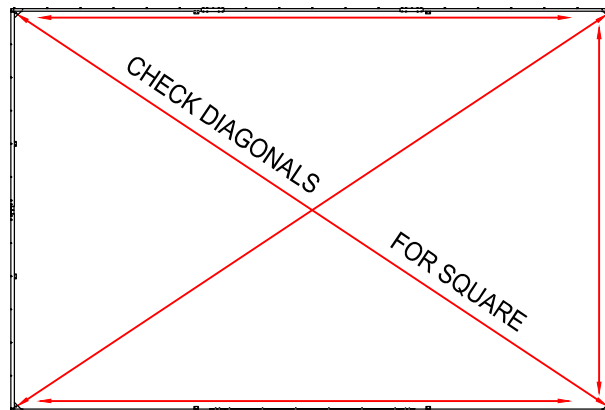

The shed is now free standing. It is critical at this stage, to ensure the shed is leveled. Also by measuring the diagonal distance, make sure the four side walls form a perfect square.

ANCHORING OF SHED

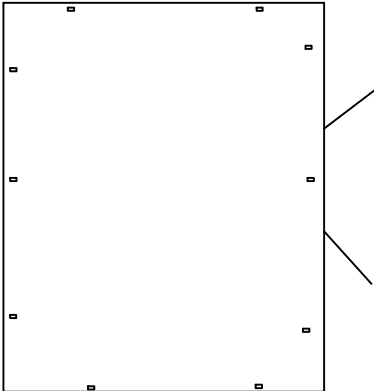

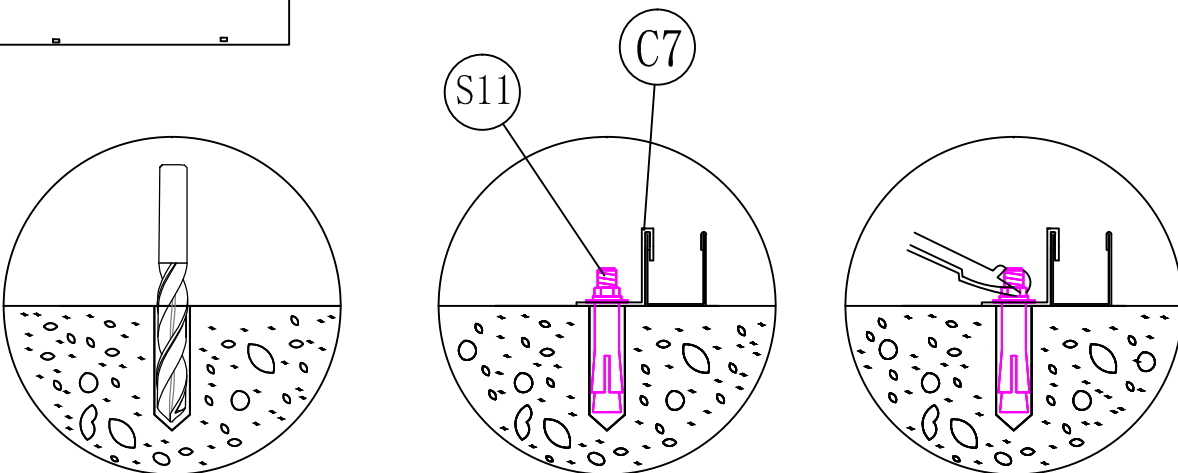

	C7	10
	S11	10

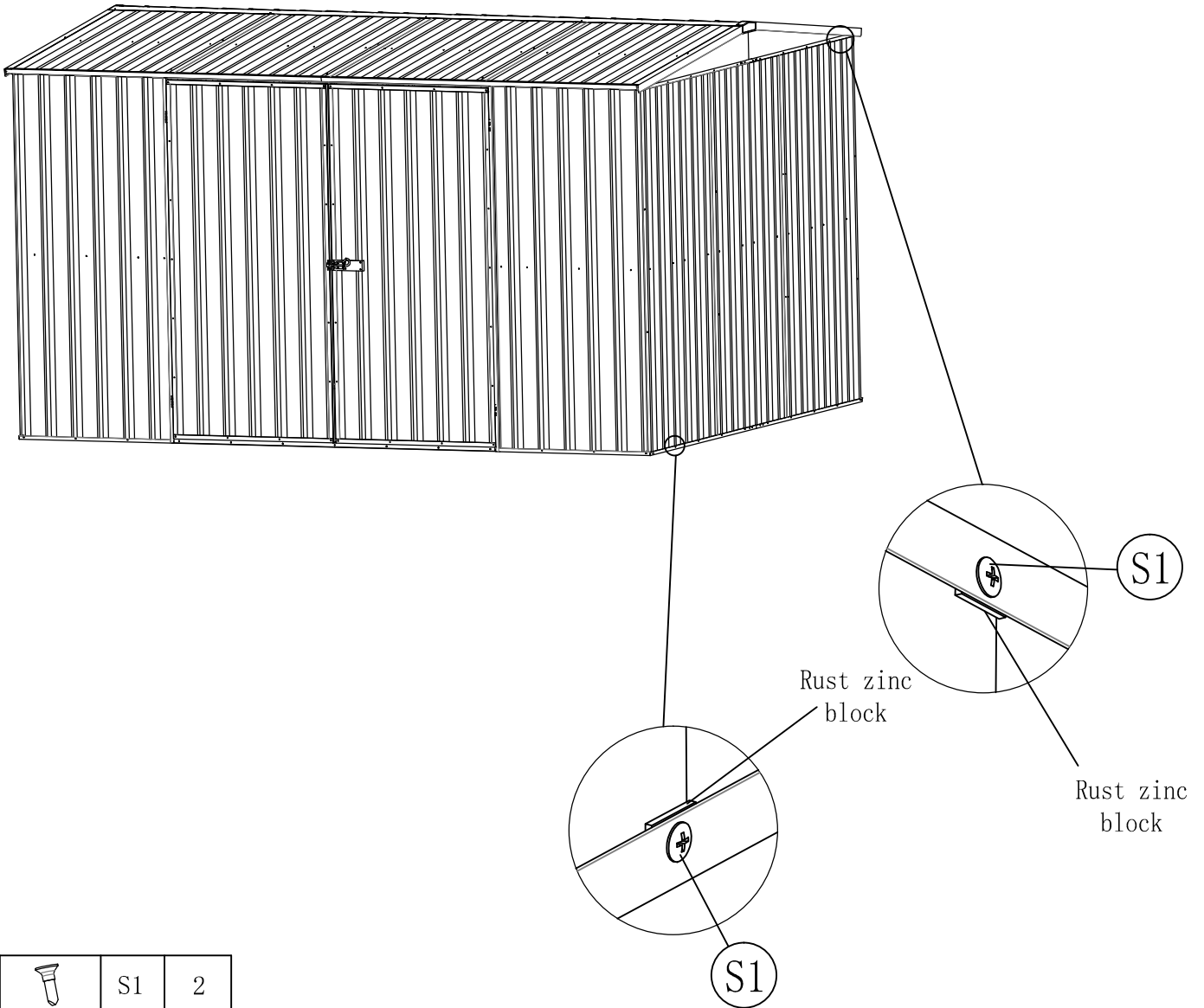

Fastening the anchor kit onto a concrete pad

1. Mark the spot of the anchor clamps on the ground
2. Use 12mm -0.39" concrete drill bit and drill holes 60mm-2.4" deep
3. Tap concrete fixing bolts into the hole, place anchor clamps, add washer and nut and fasten.



	S1	2
	Rust zinc block	2

Tips: Please make Pre punching in Rust zinc block, which is easy for installing.